

## Tafeln

In: Podborský, Vladimír. *Mähren in der Spätbronzezeit und an der Schwelle der Eisenzeit*. Vyd. 1. Brno: Universita J.E. Purkyně, 1970, pp.

Stable URL (handle): <https://hdl.handle.net/11222.digilib/120253>

Access Date: 16. 02. 2024

Version: 20220831

Terms of use: Digital Library of the Faculty of Arts, Masaryk University provides access to digitized documents strictly for personal use, unless otherwise specified.

**T A F E L N**



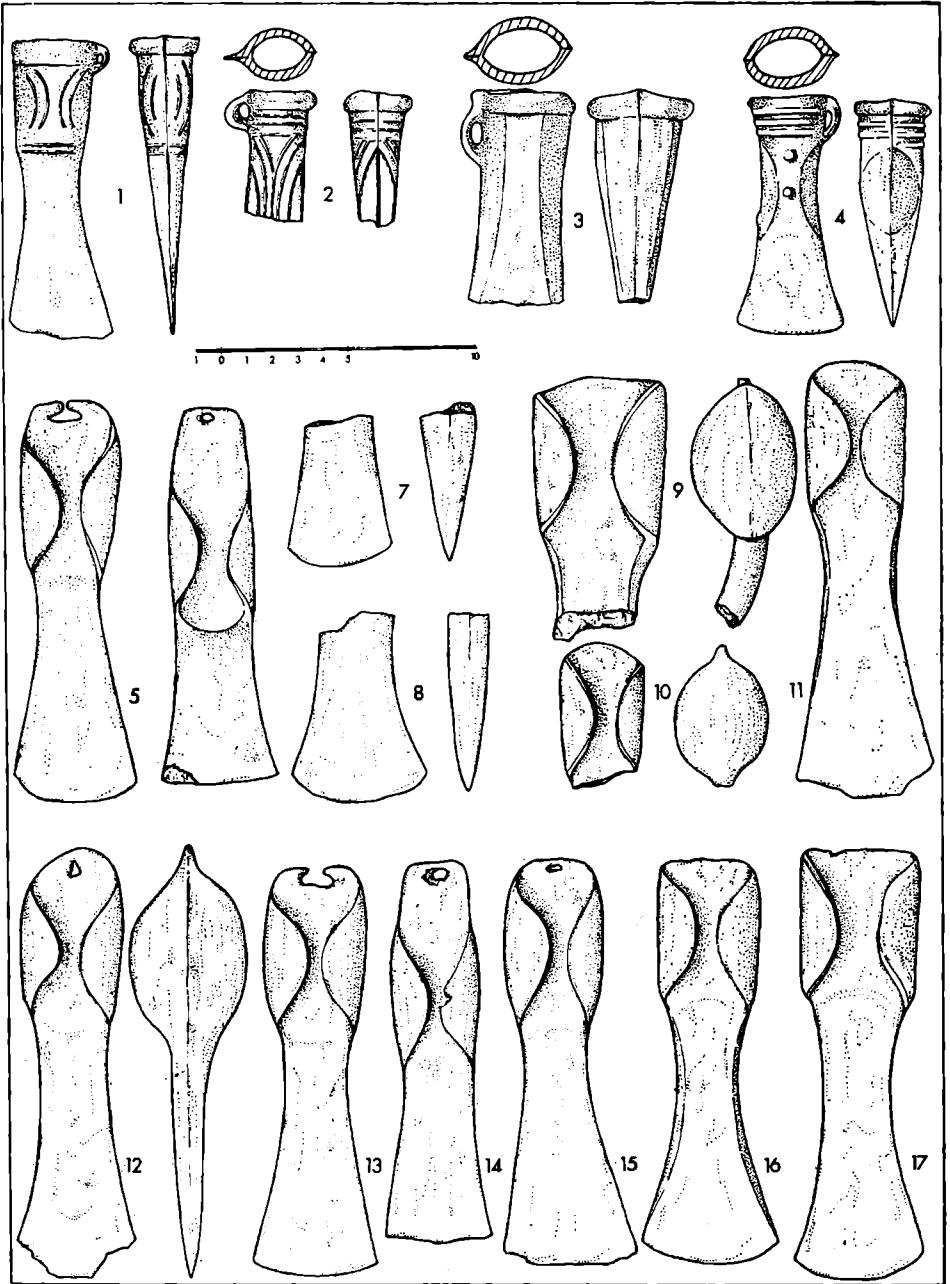

Taf. 1 — Kufim, Bronzedepot (1. Teil)

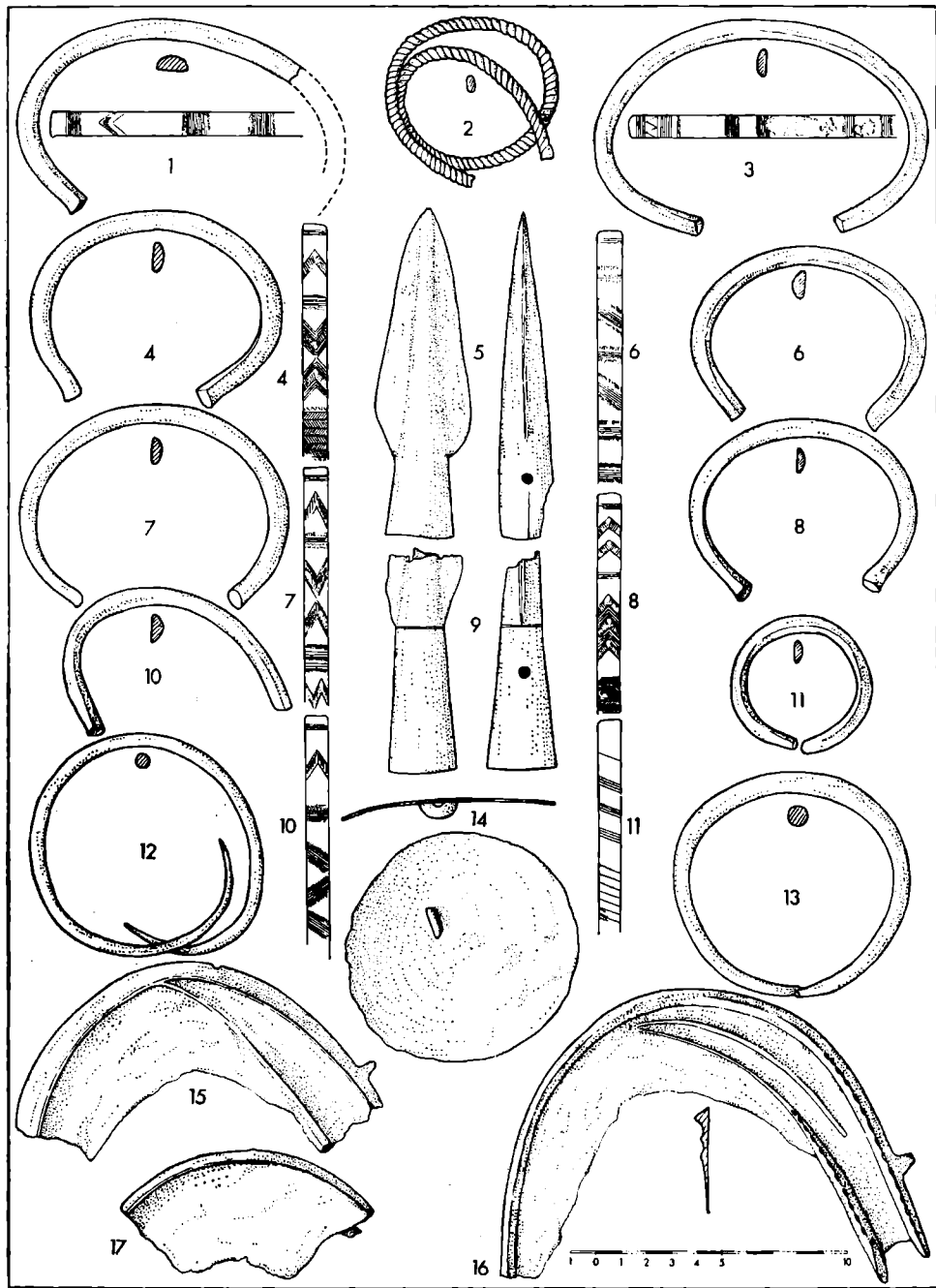

Taf. 2 — Kuřim, Bronzedepot (2. Teil)

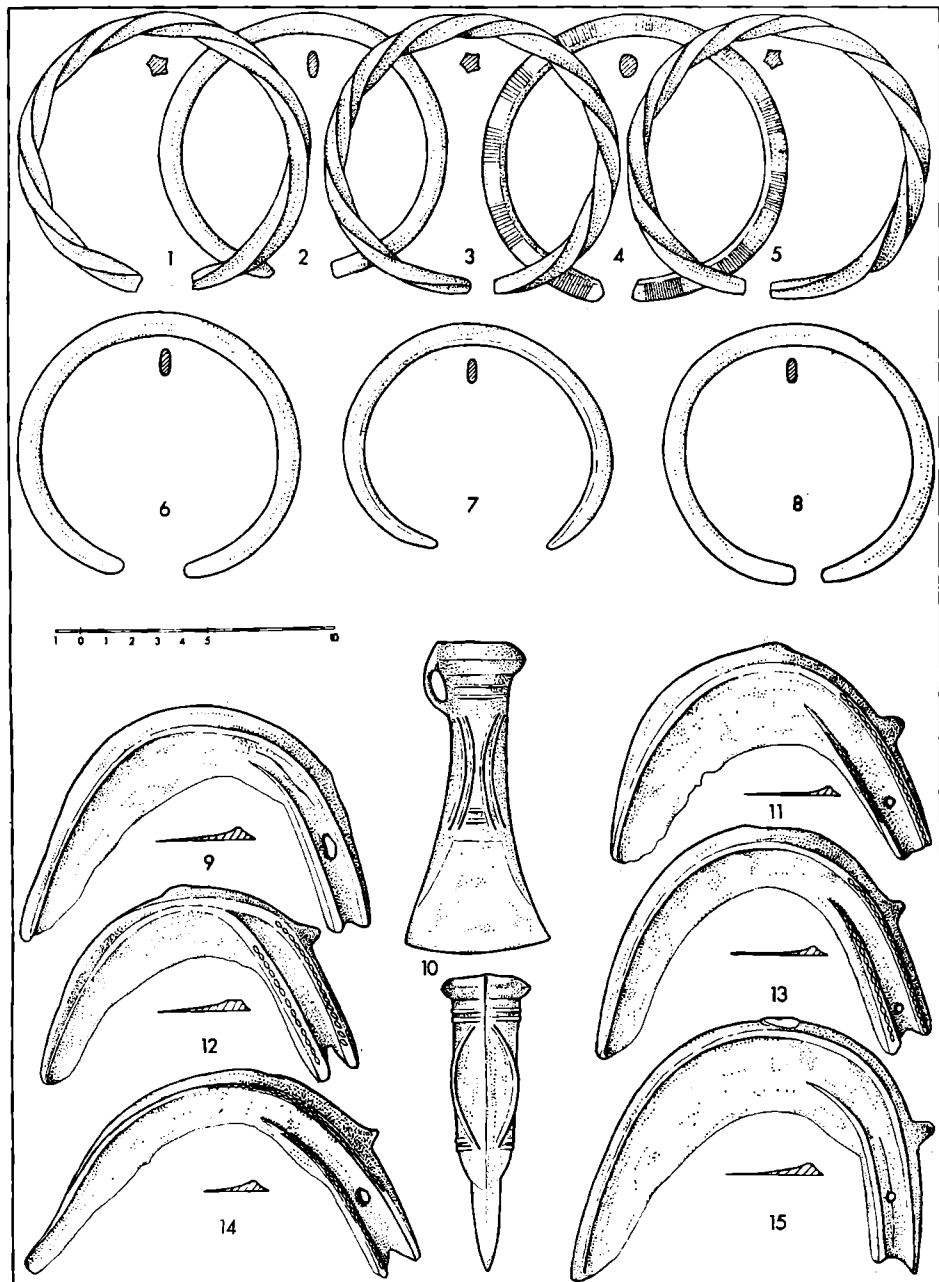

Taf. 3 — Železné, Bronzedeopot

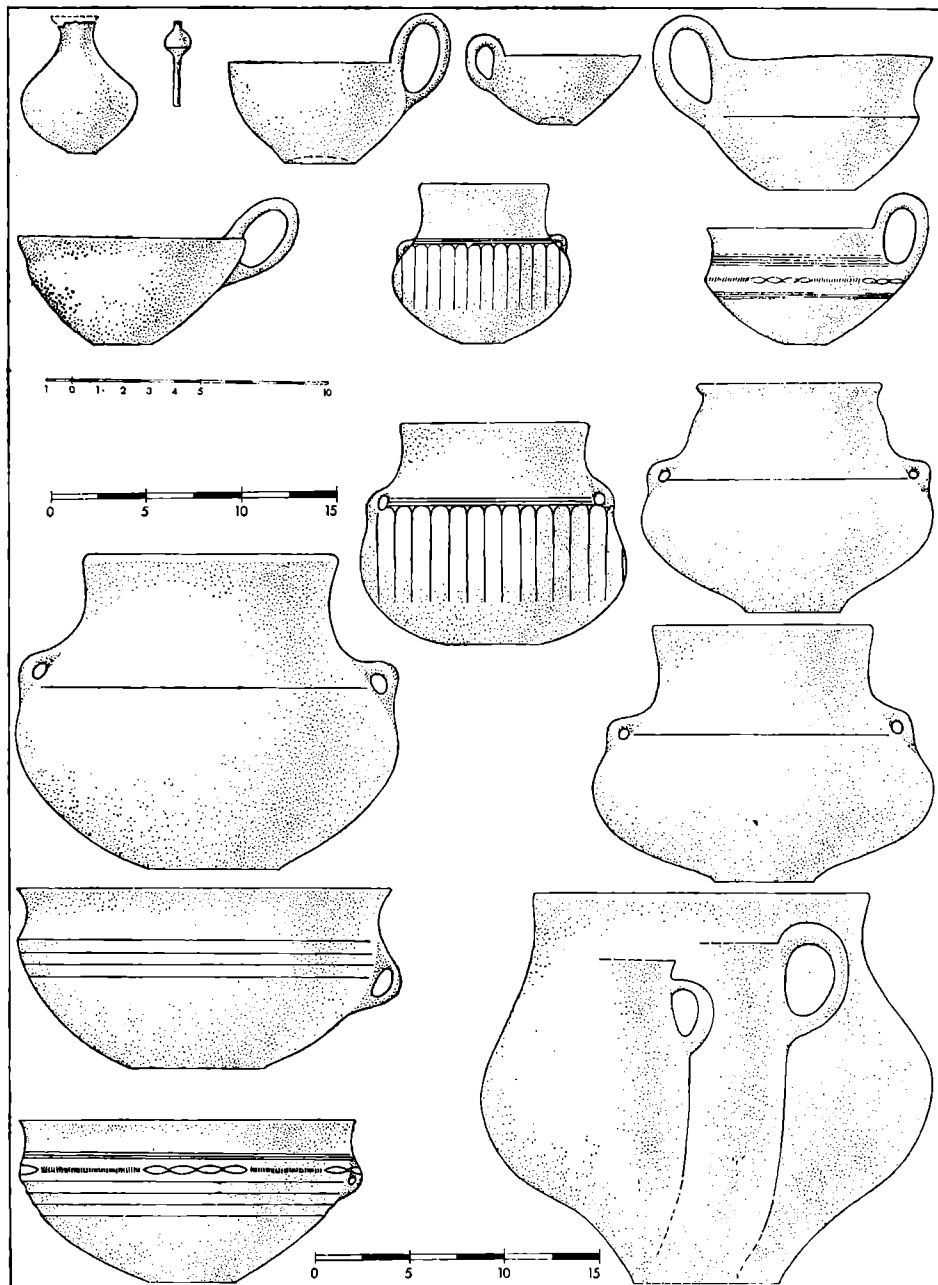

Taf. 4 — Domamyslice, Grab 196

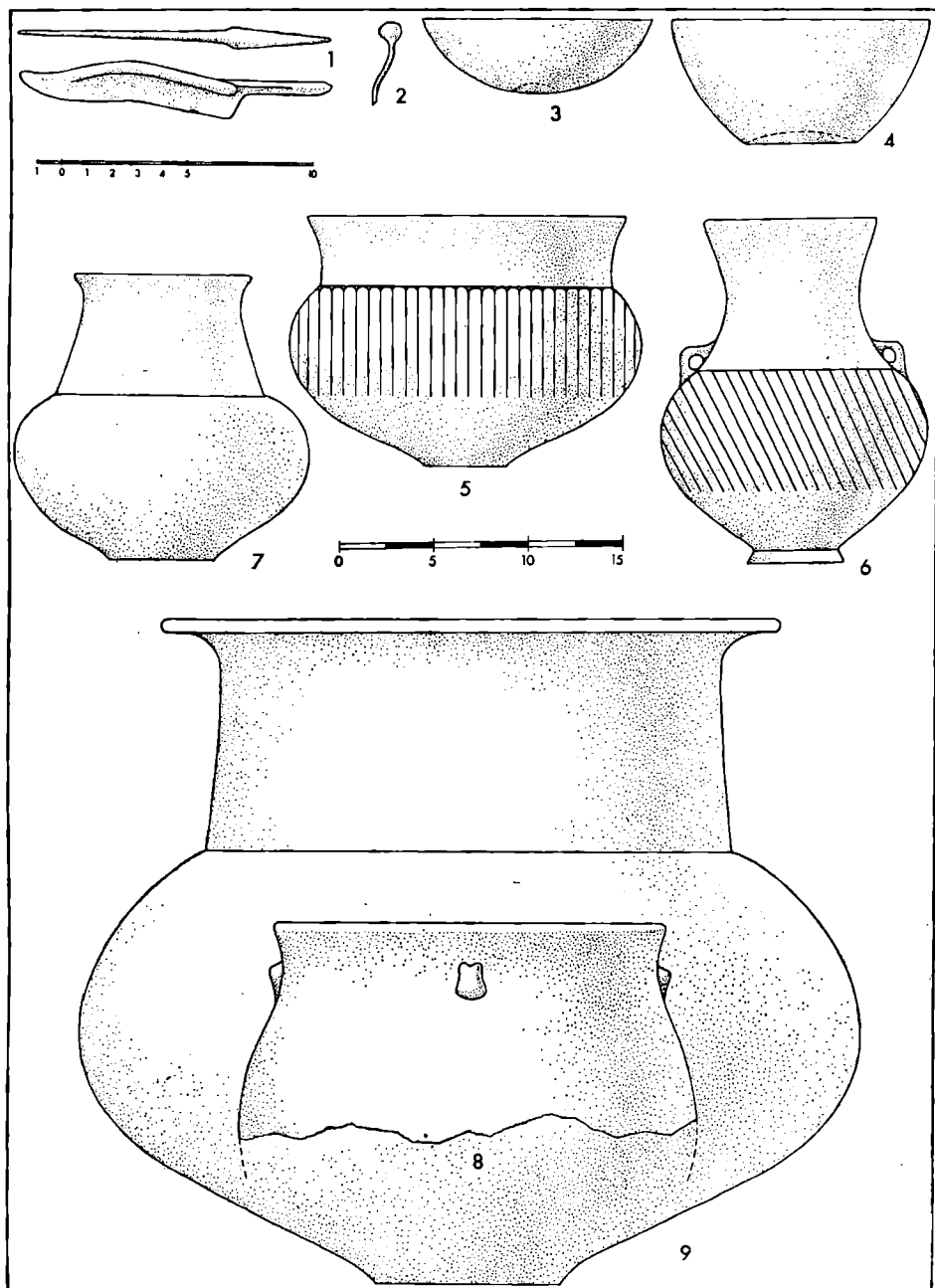

Taf. 5 — Klentnice, Grab 105



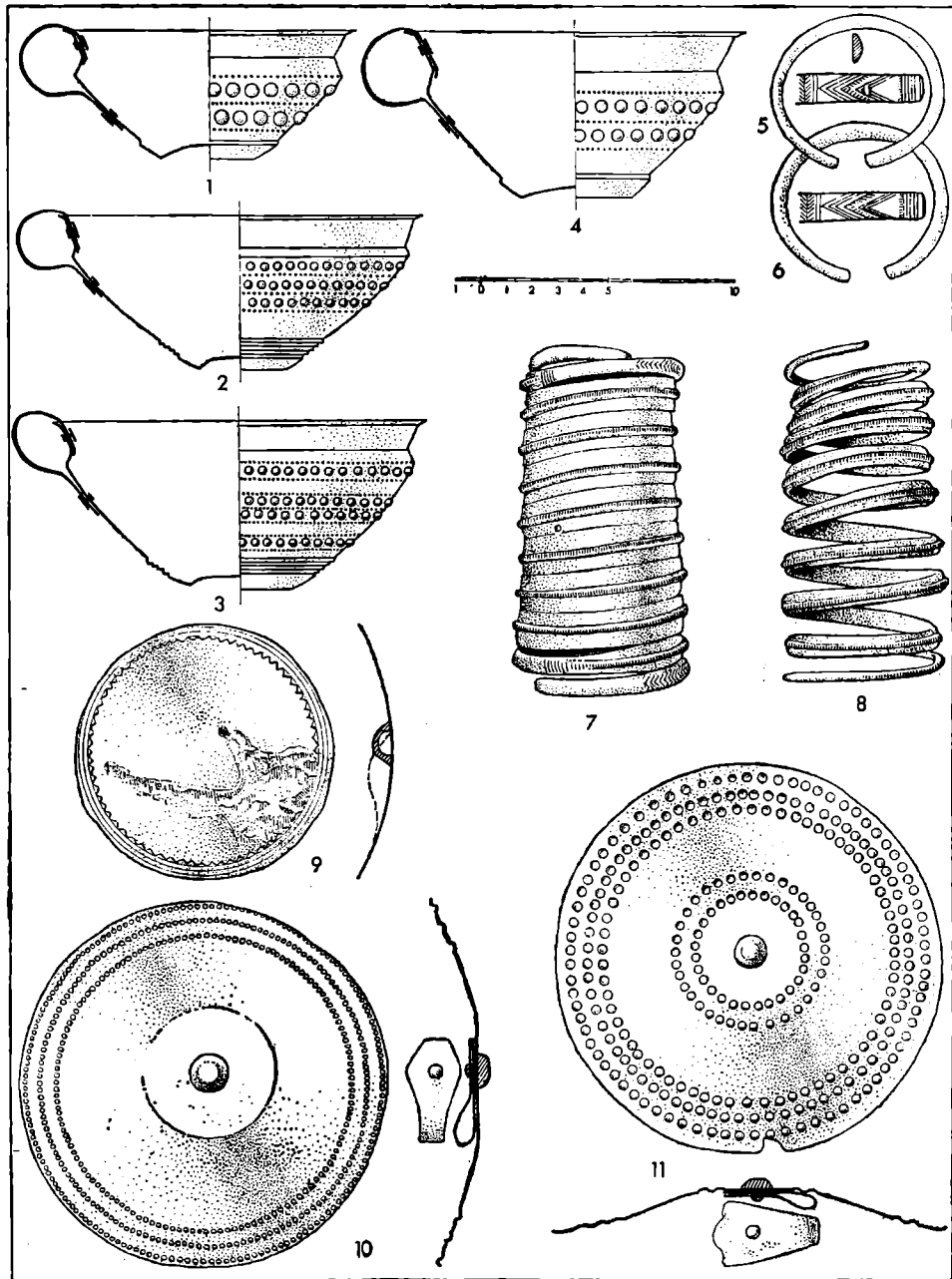

Taf. 6 — Kfenůvky, Bronzedeopot

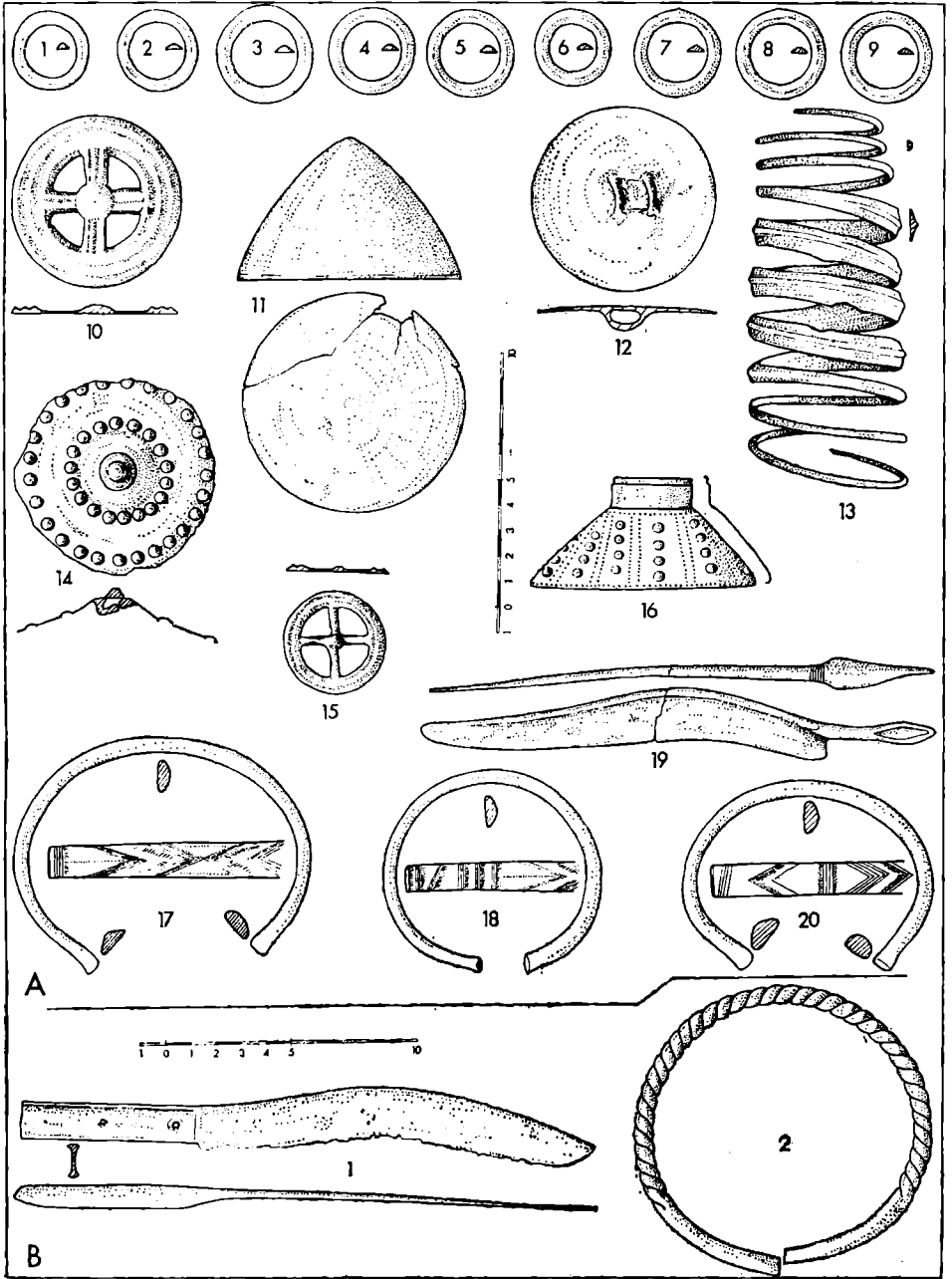

Taf. 7 — Malhostovice, Bronzedept Nr. 1 (A) und Reste vom Depot Nr. 2 (B)

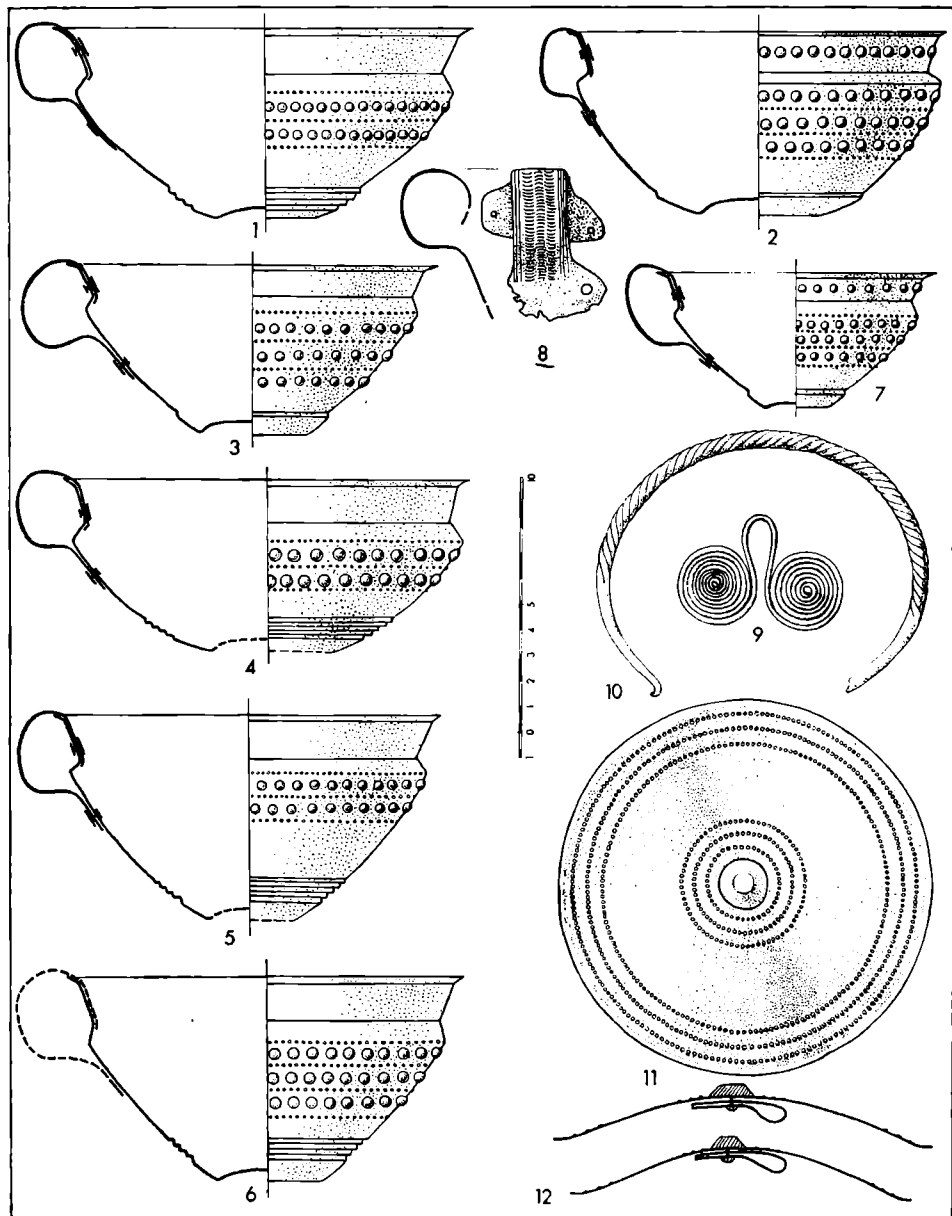

Taf. 8 — Štramperk-Kotouč, Bronzedeopot 2

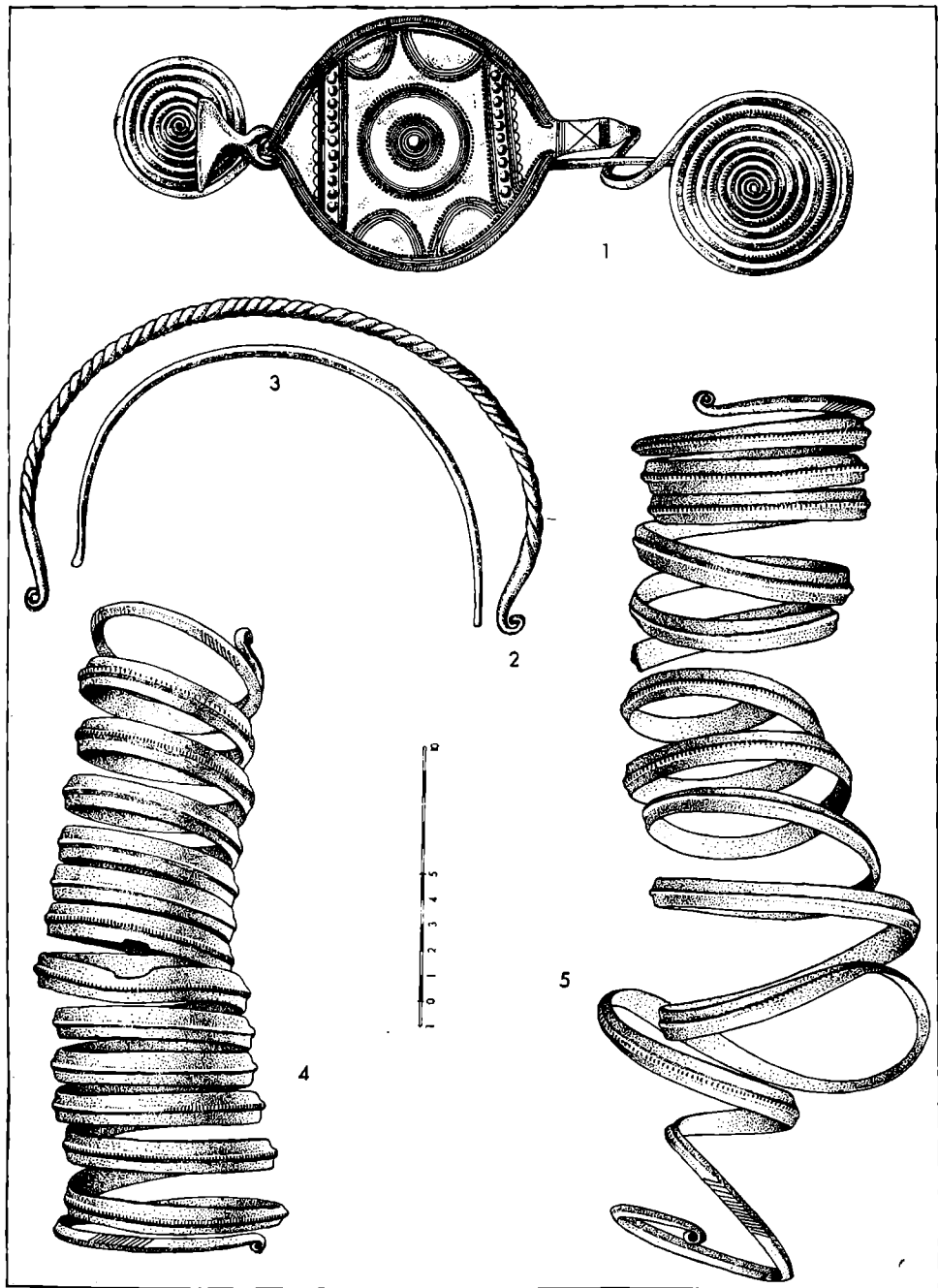

Taf. 9 — Štramberk-Kotouč, Bronzedept 3

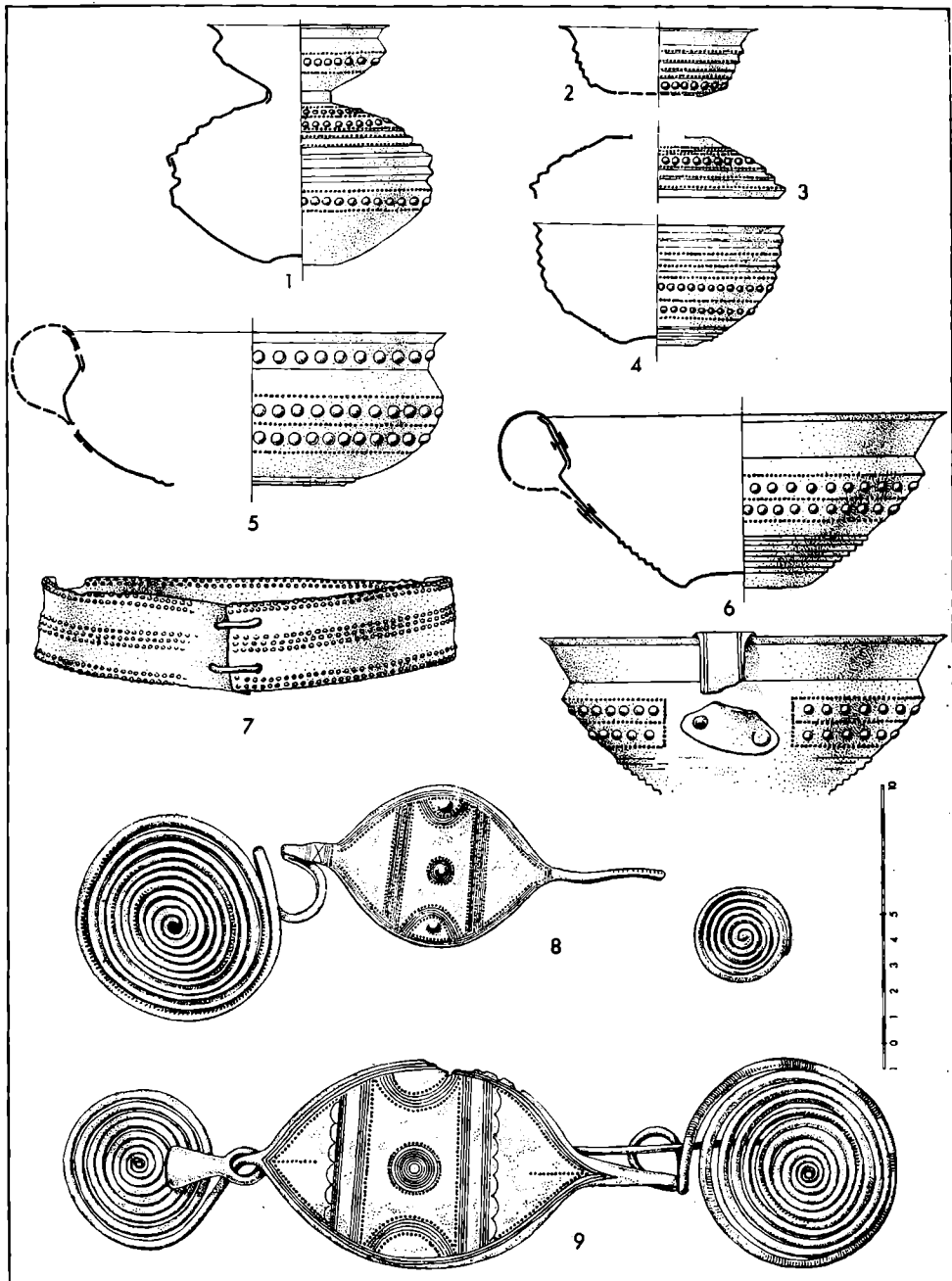

Taf. 10 — Štramberk-Kotouč, Bronzedepot 4 (1. Teil)

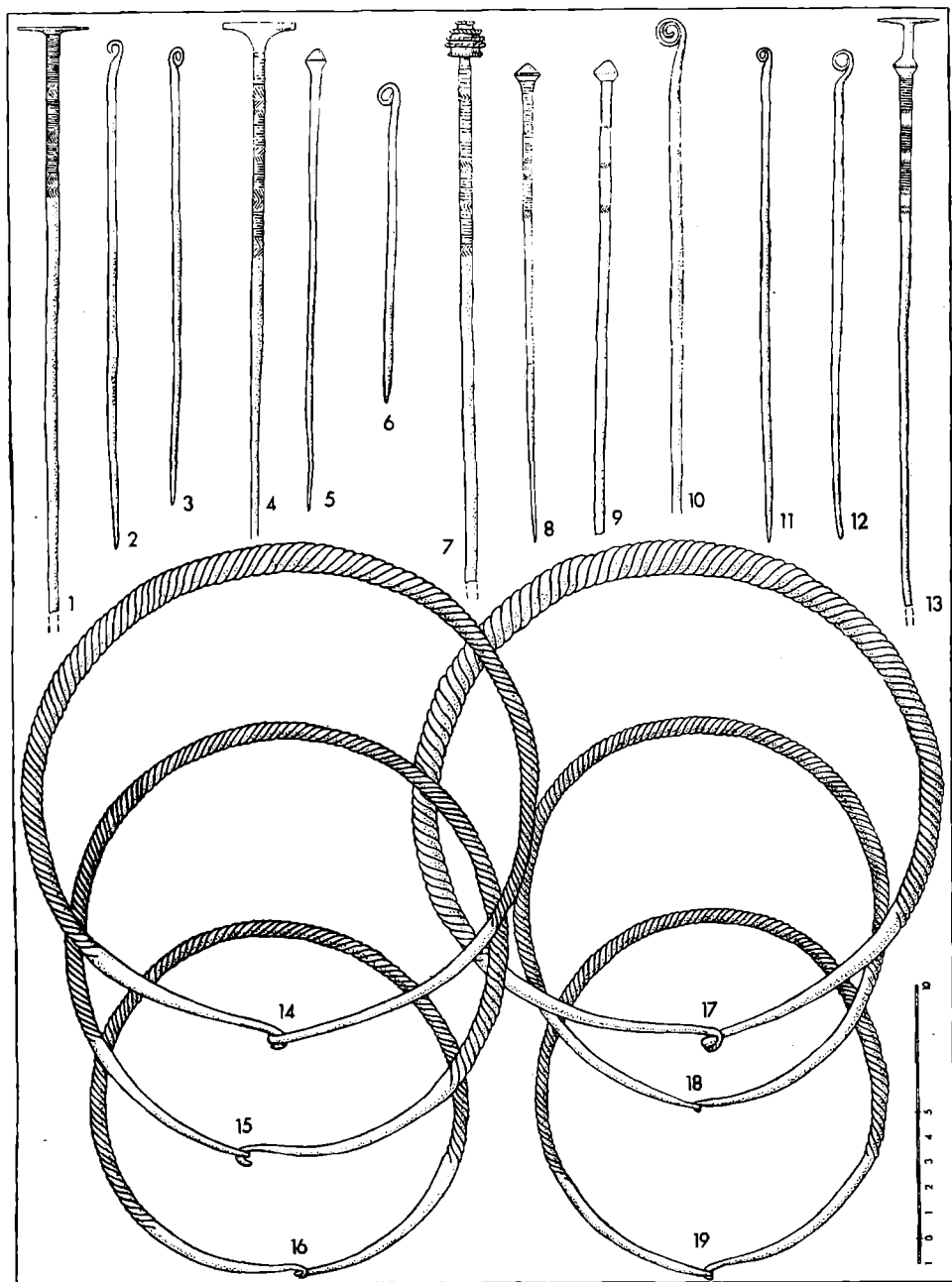

Taf. 11 — Štrambersk-Kotouč, Bronzedepot 4 (2. Teil)

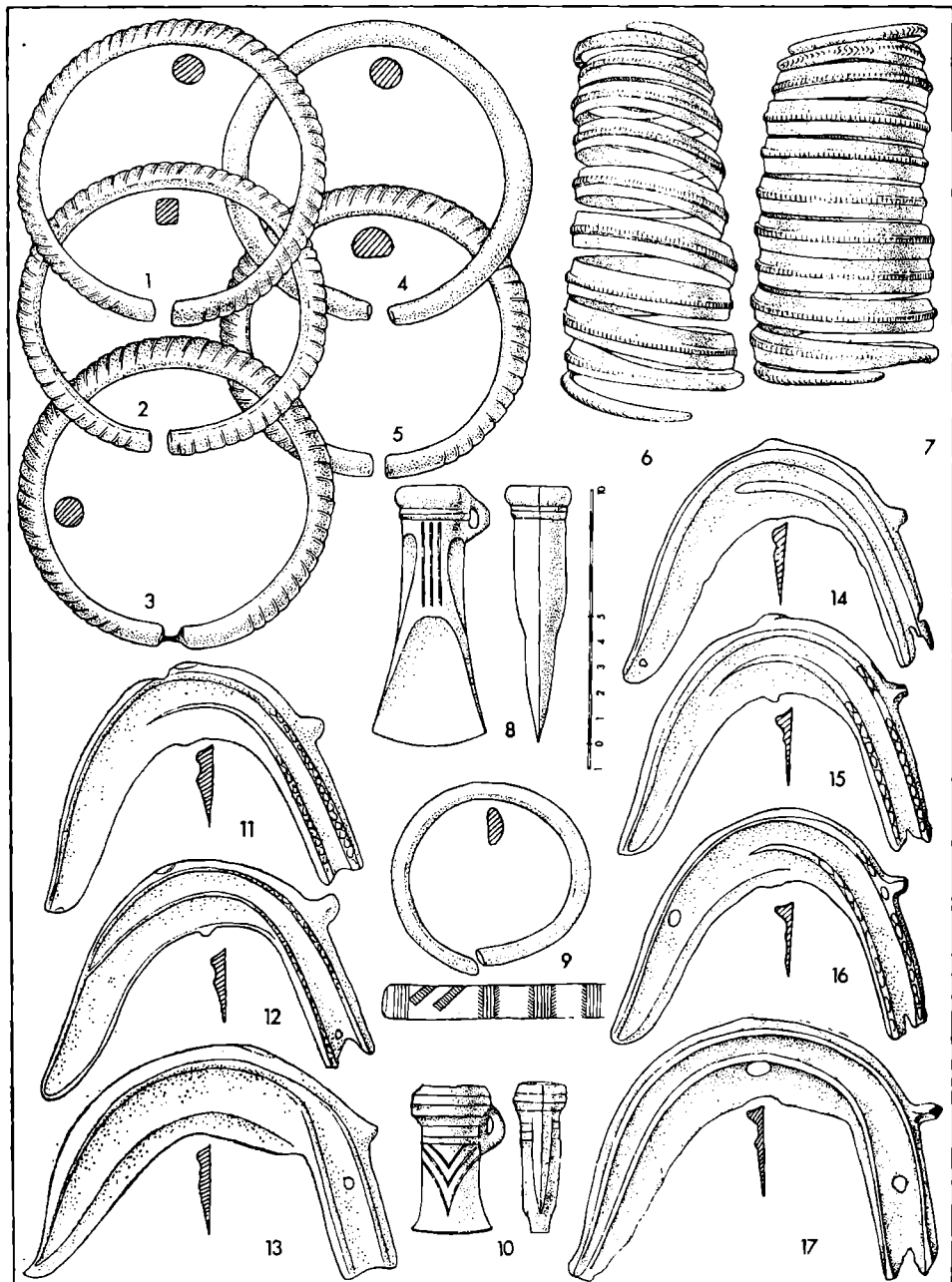

Taf. 12 — Štramberk-Kotouč, Bronzedepot 4 (3. Teil)

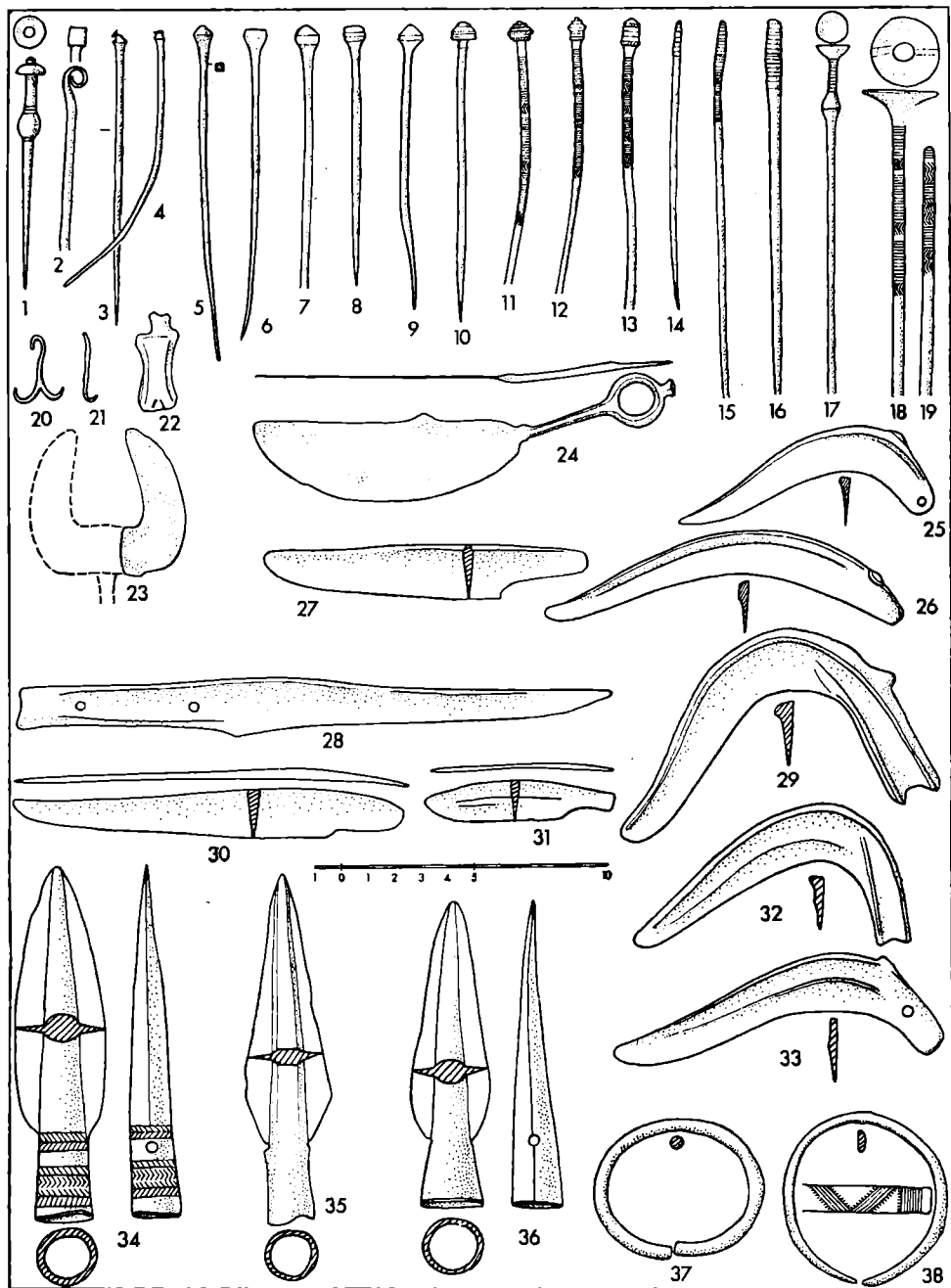

Taf. 13 — Štramberk-Kotouč, Zufallsfunde



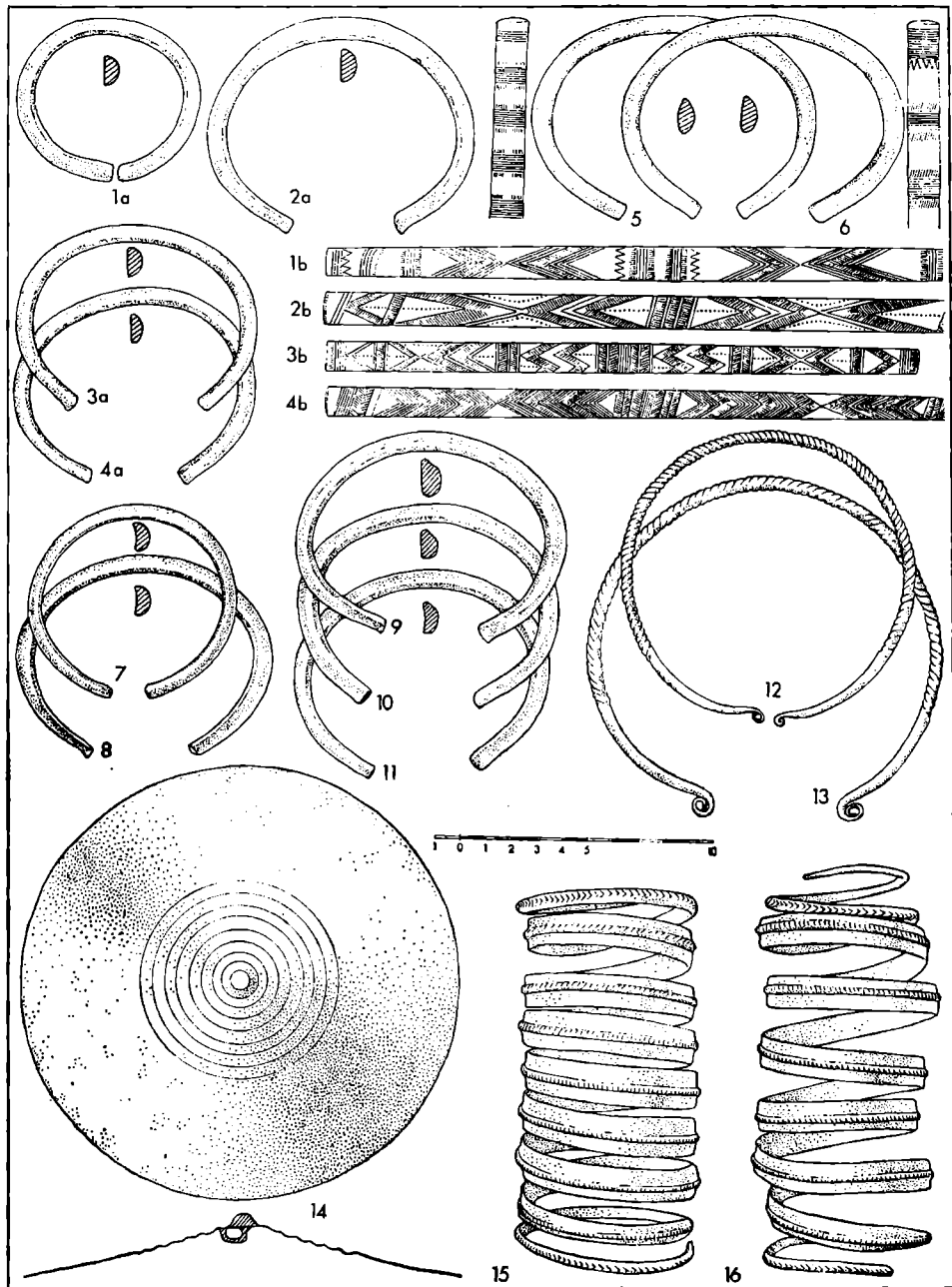

Taf. 14 — Zastávka, Bronzedepot

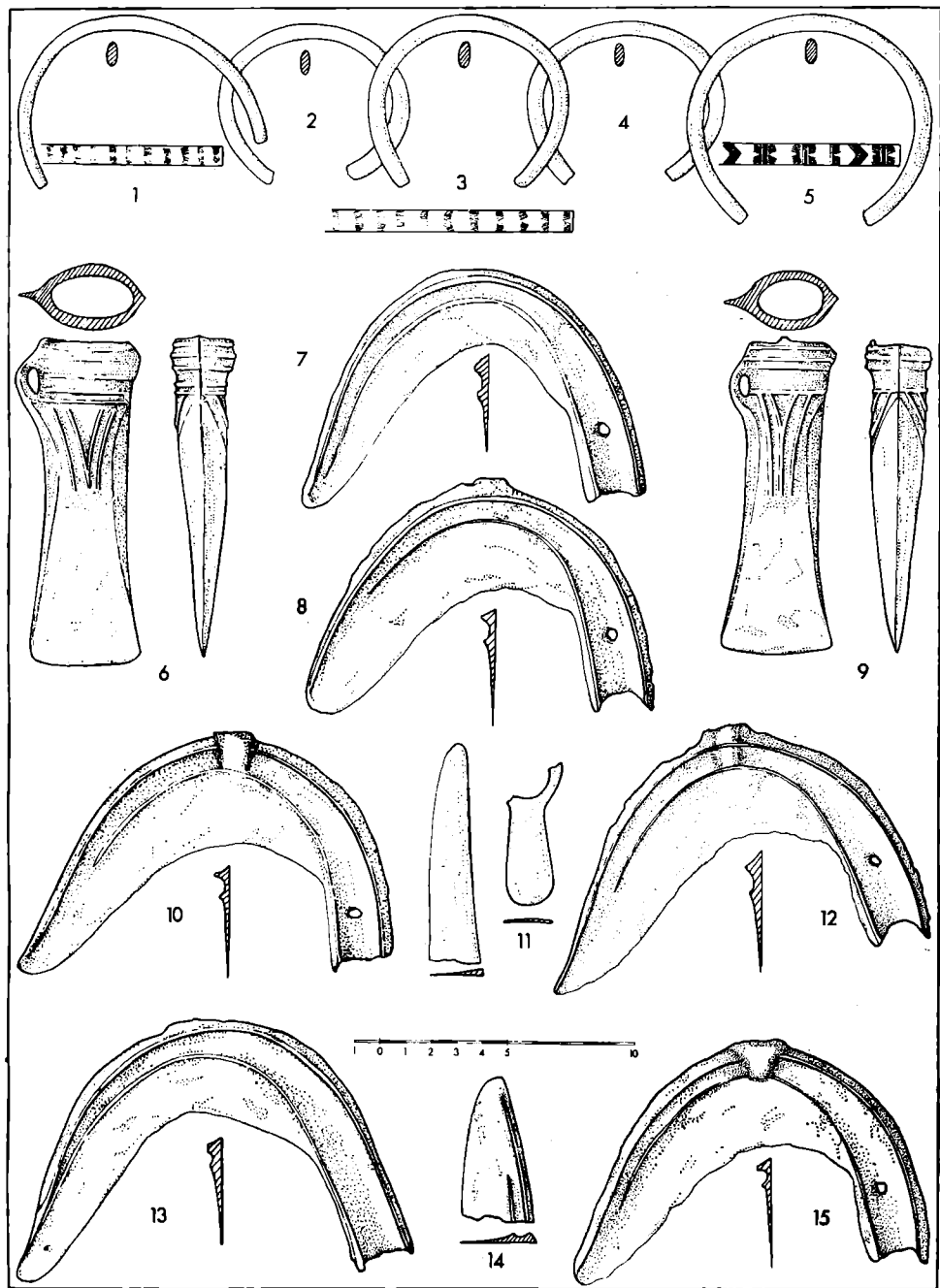

Taf. 15 — Klentnice, Bronzedeopot

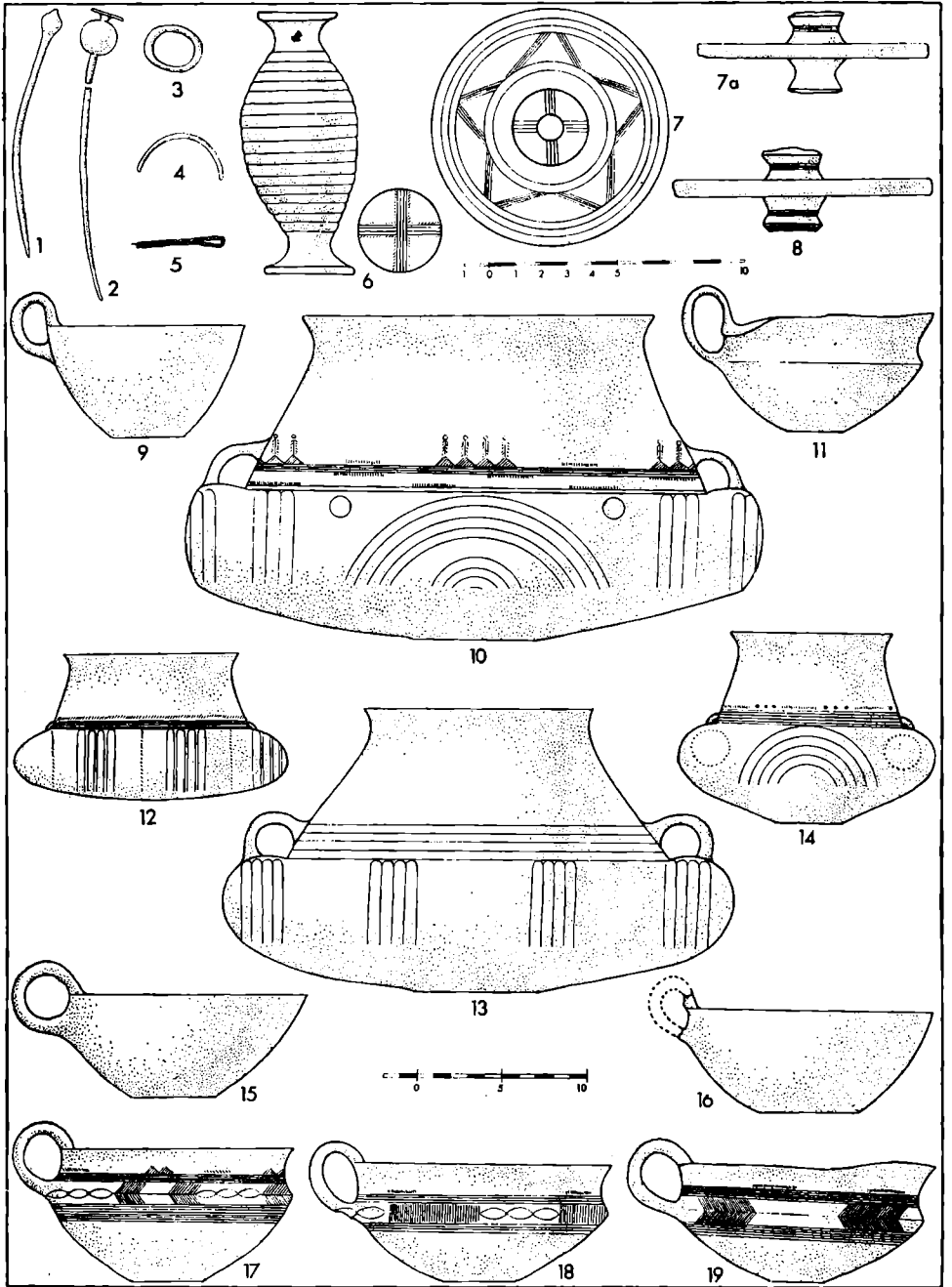

Taf. 16 — Domamyslice, Grab 12 (1. Teil)

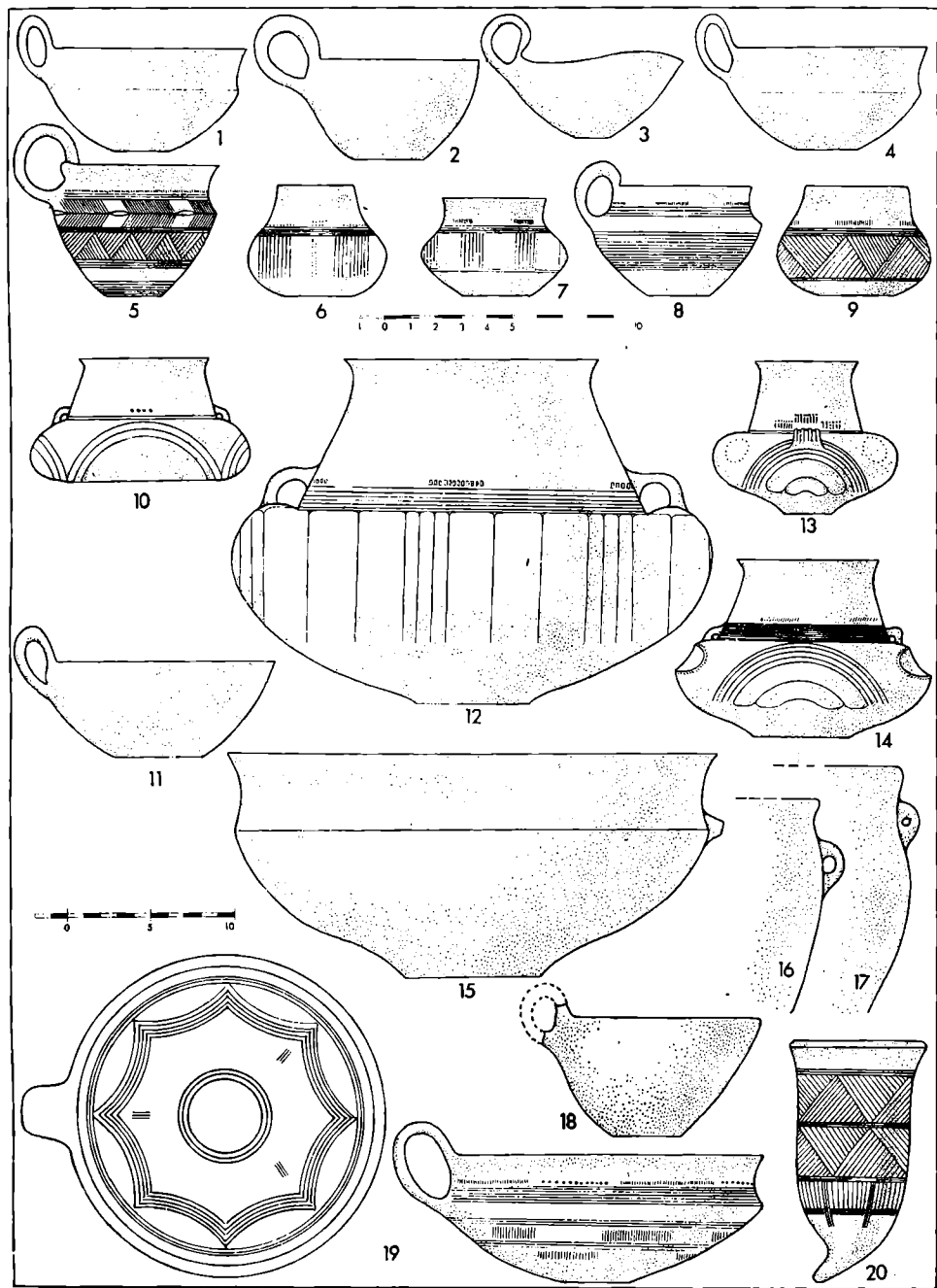

Taf. 17 — Domamyslice, Grab 12 (2. Teil)

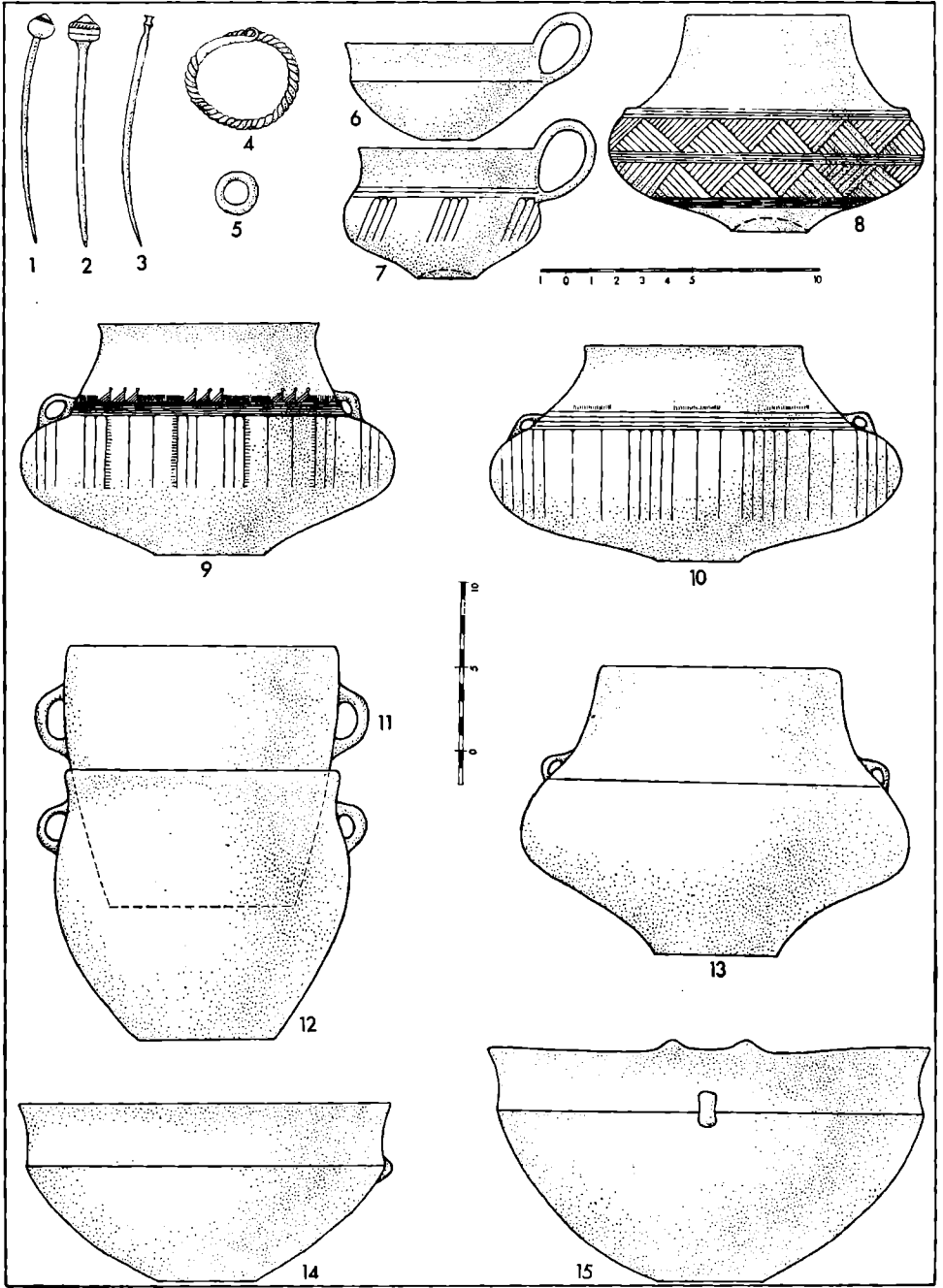

Taf. 18 — Domamyslice, Grab 33

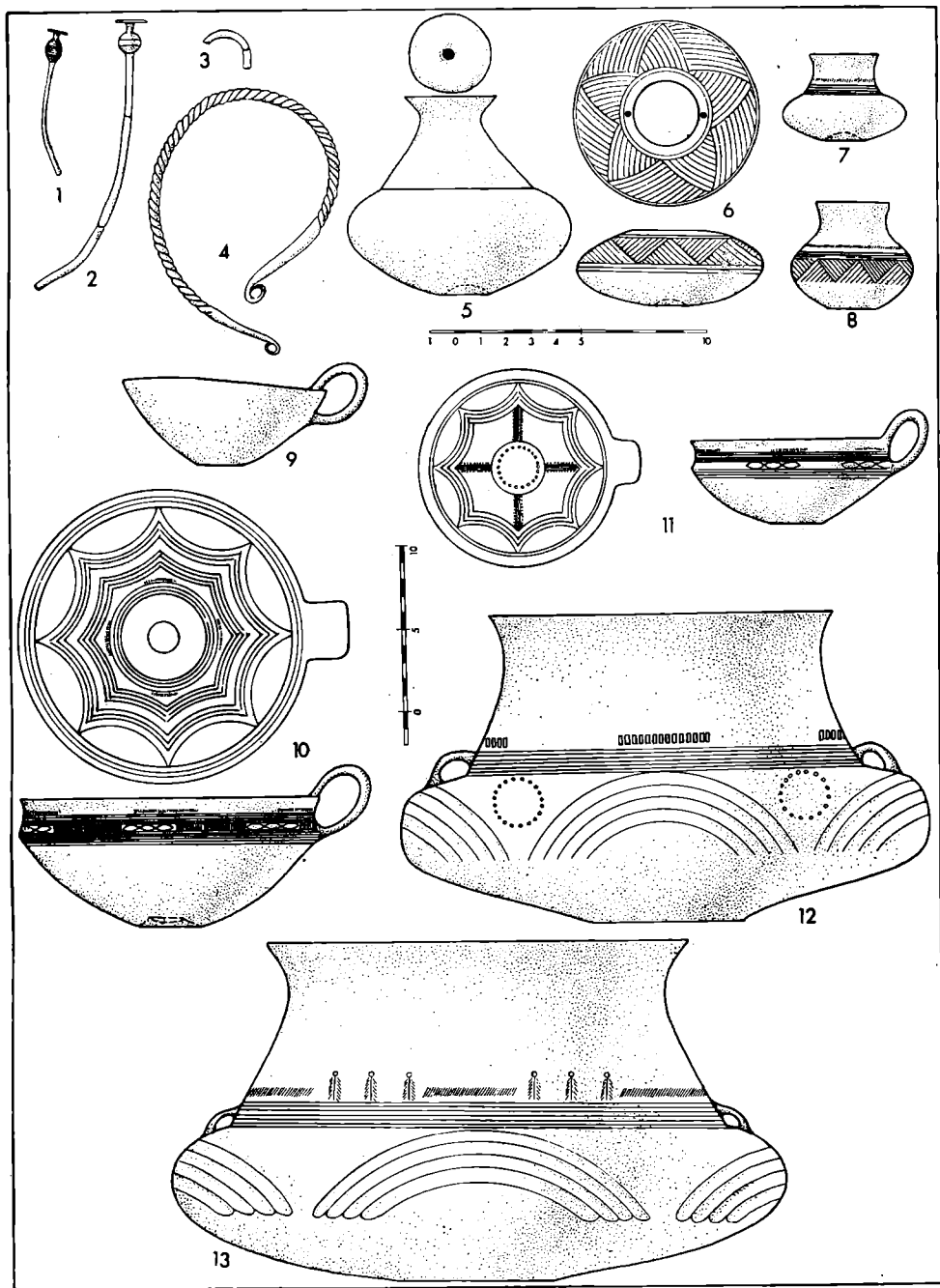

Taf. 19 — Domamyslice, Grab 85

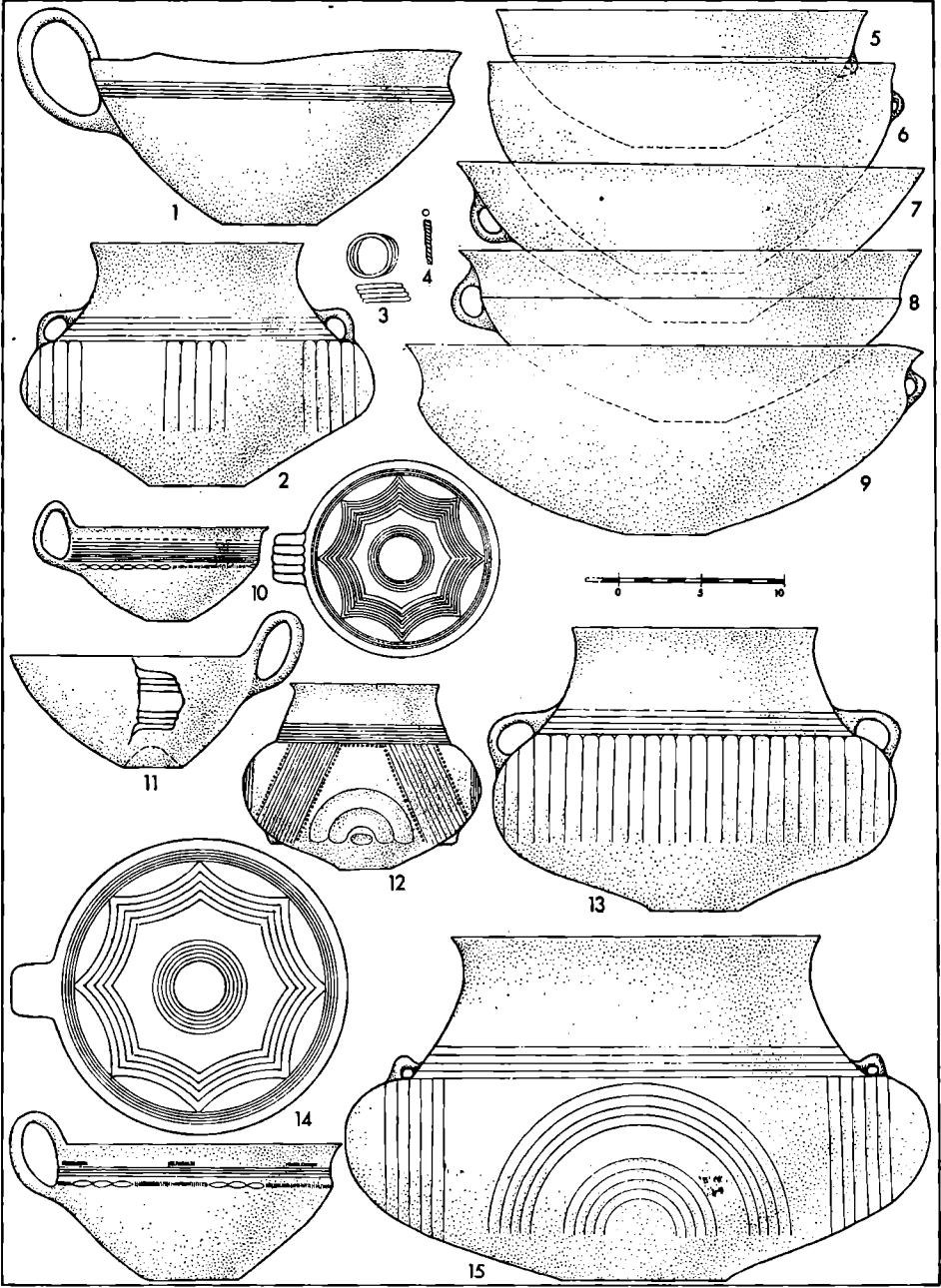

Taf. 20 — Domamyslice, Grab 74

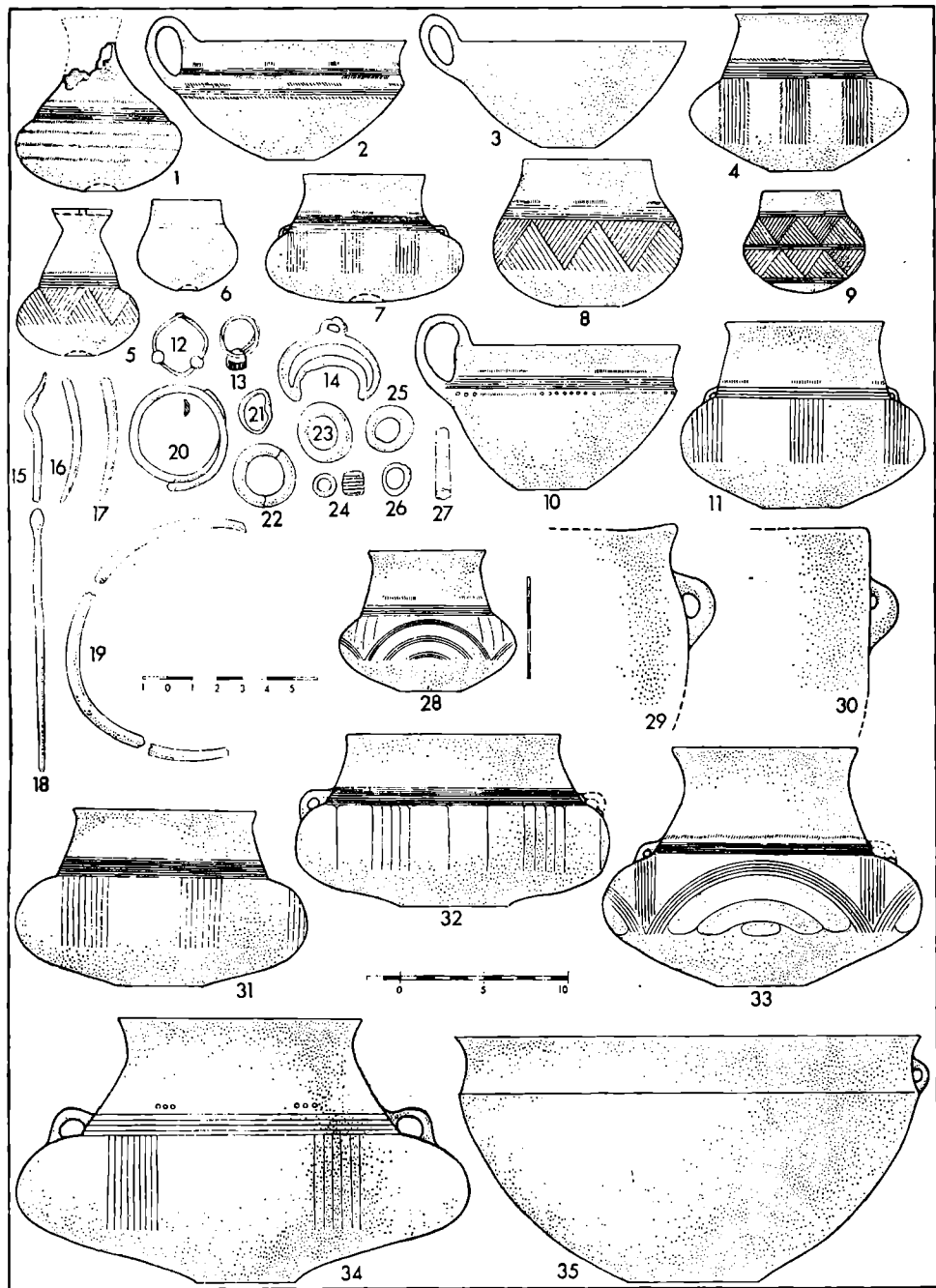

Taf. 21 — Domamyslice, Grab 97



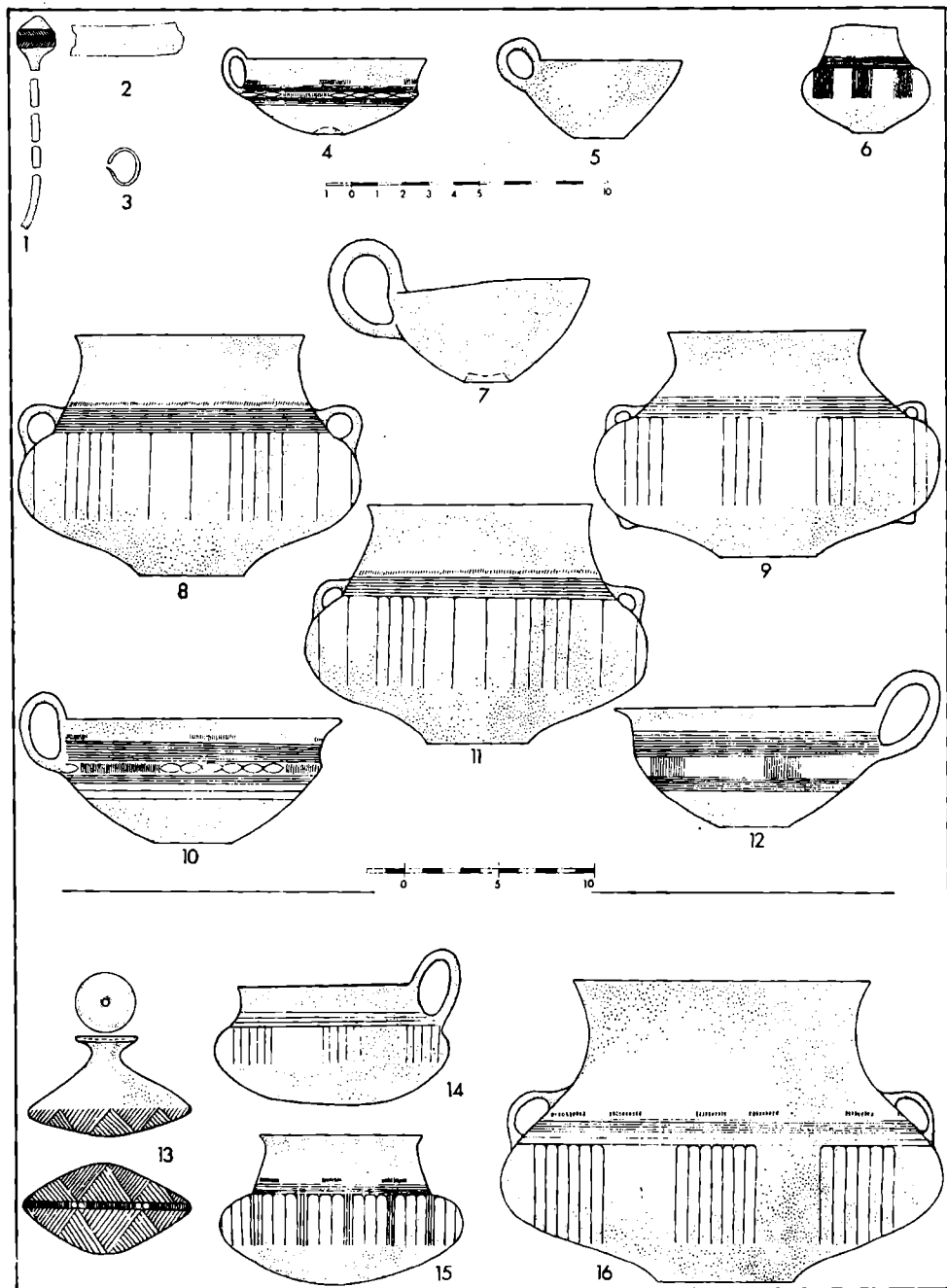

Taf. 22 — 1–12 — Slatinky, Grab 14; 13–16 — Určice, Grab 11

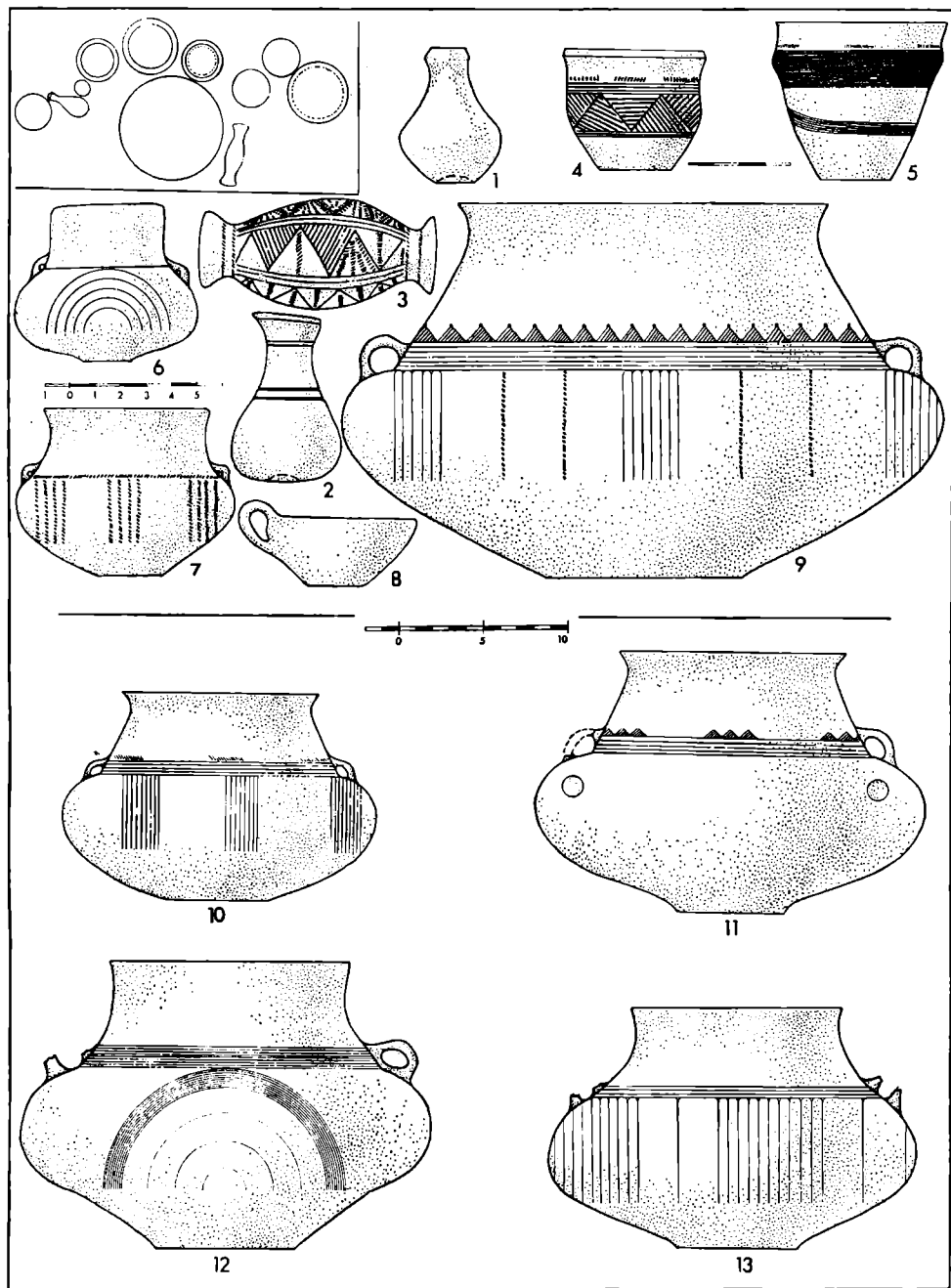

Taf. 23 — 1–9 — Určice, Grab 4; 10–11 — Tršice; 12–13 — Dubicko

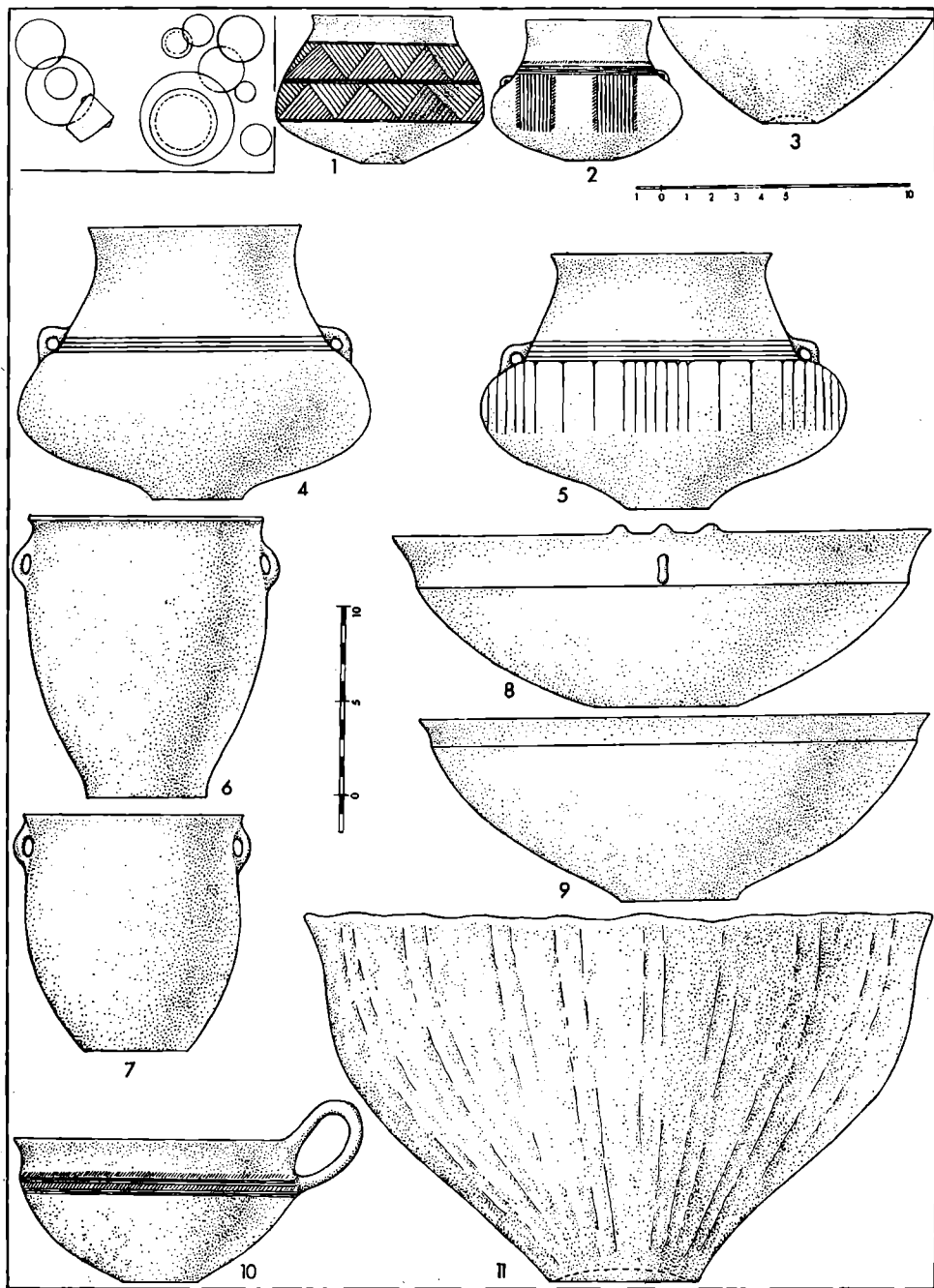

Taf. 24 — Určice, Grab 158

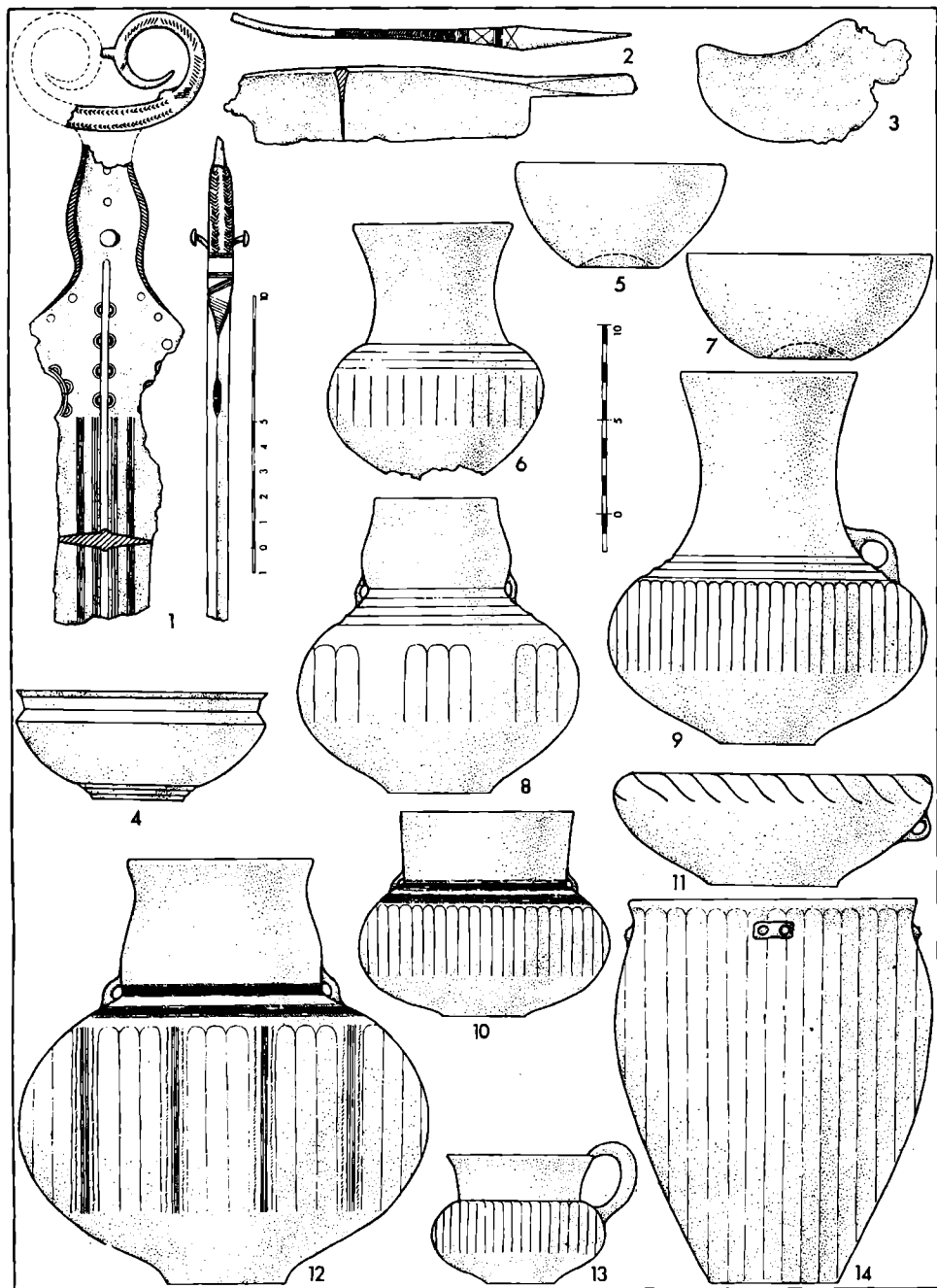

Taf. 25 — Klentnice, Grab 63

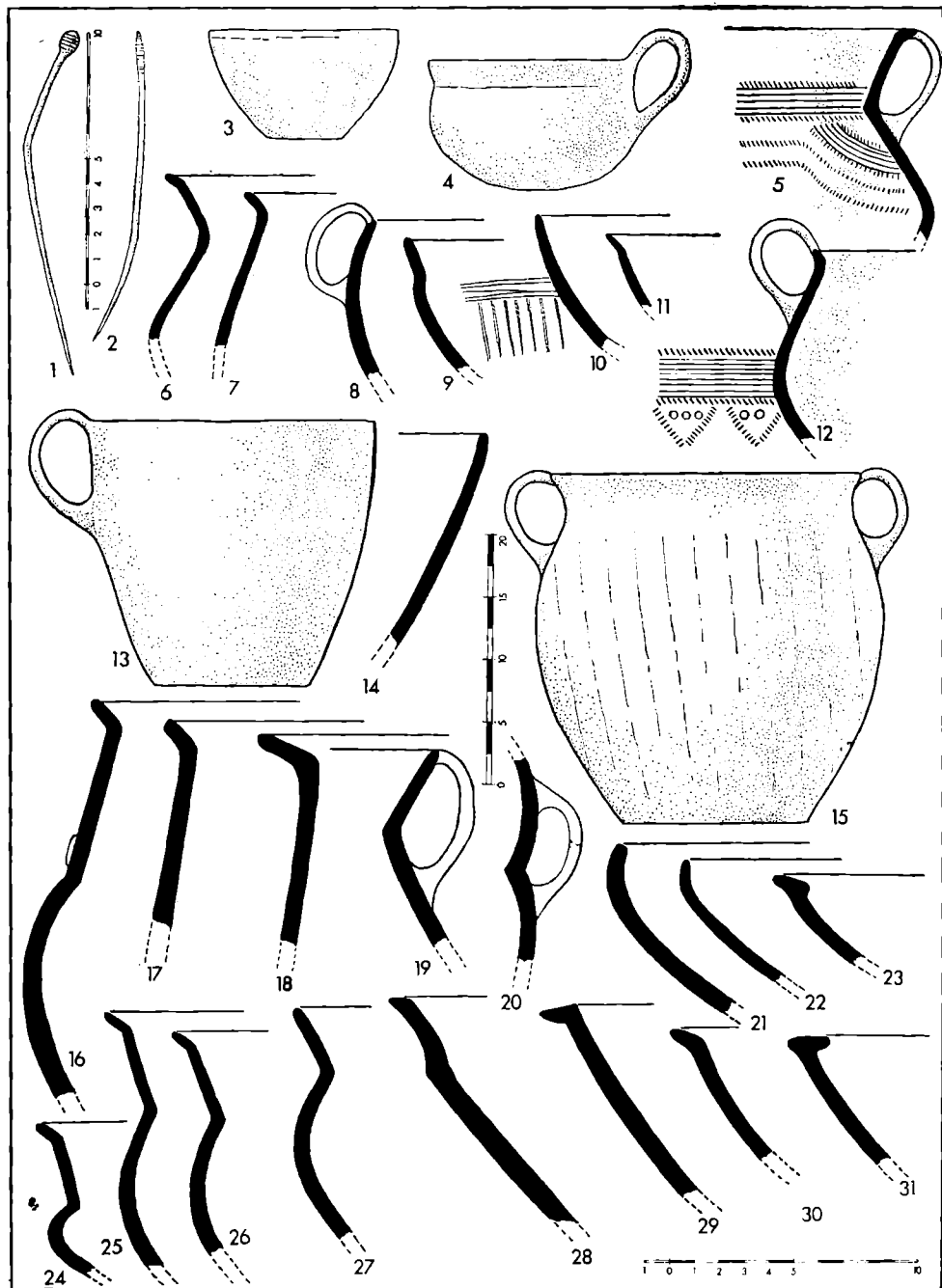

Taf. 26 — Brno-Obřany, Objekt XV

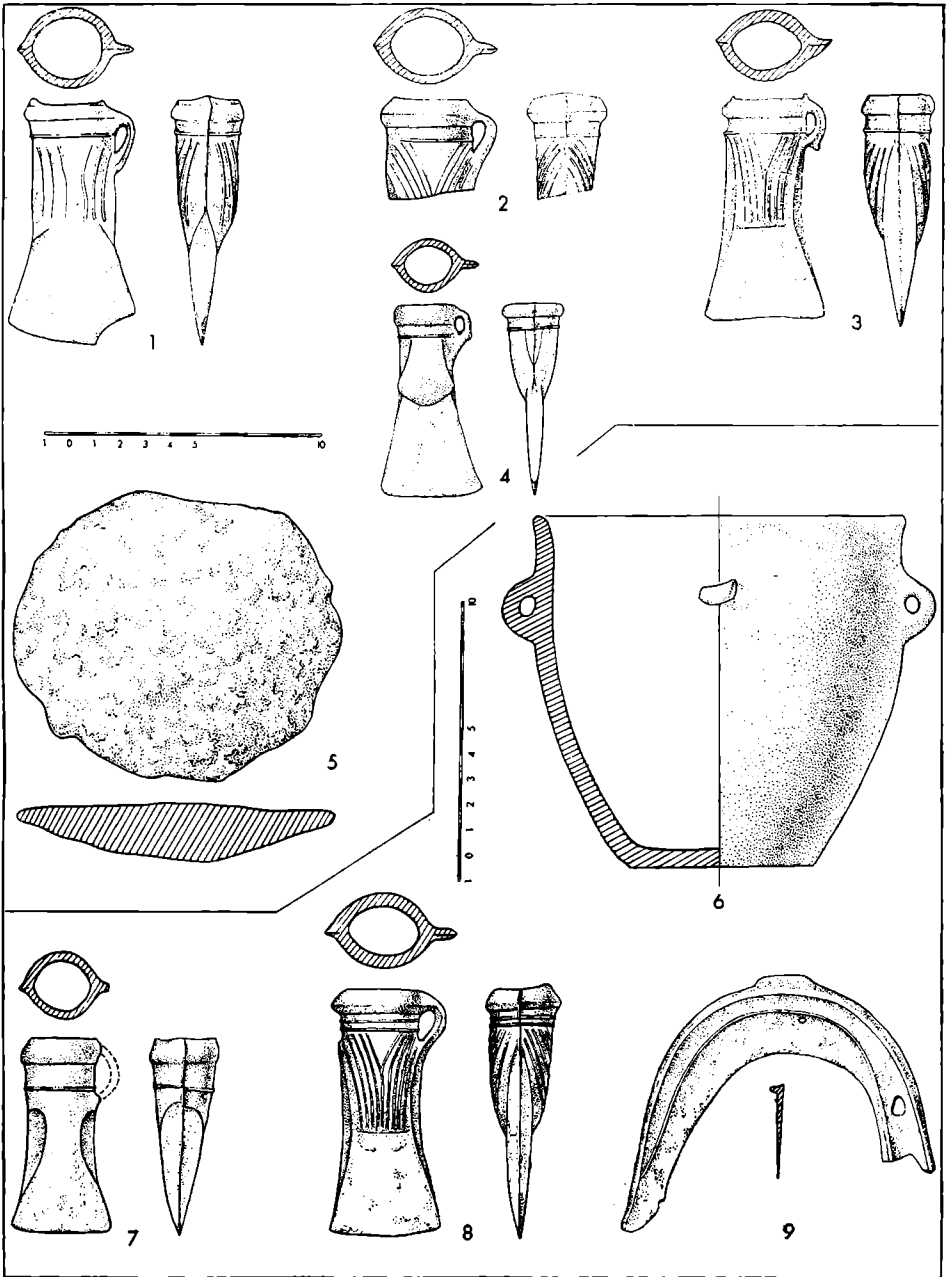

Taf. 27 — Boskovice, Bronzedepts 1 (Nr. 1–5) und 3 (Nr. 6–9)

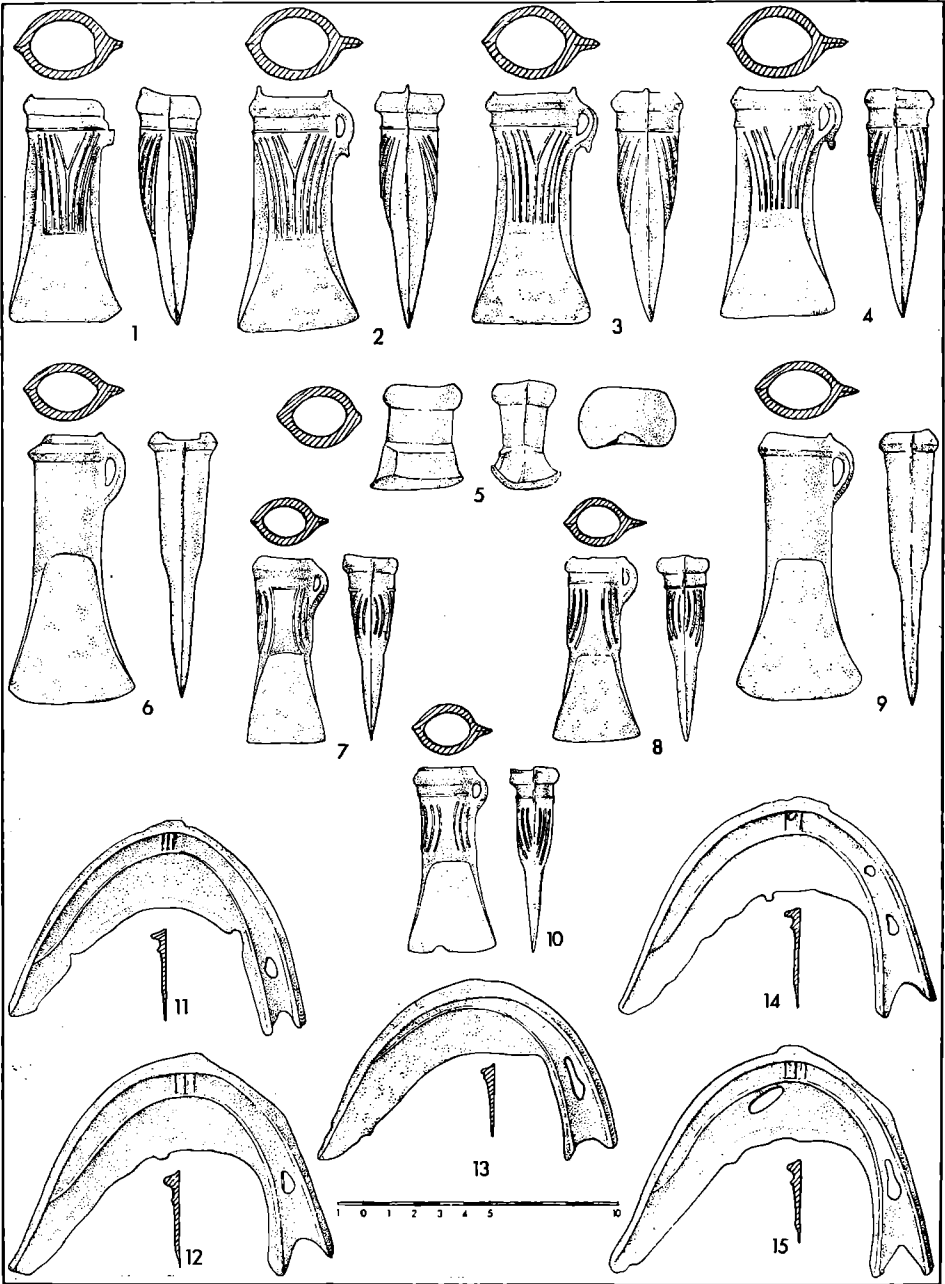

Taf. 28 — Boskovice, Bronzedepot 4

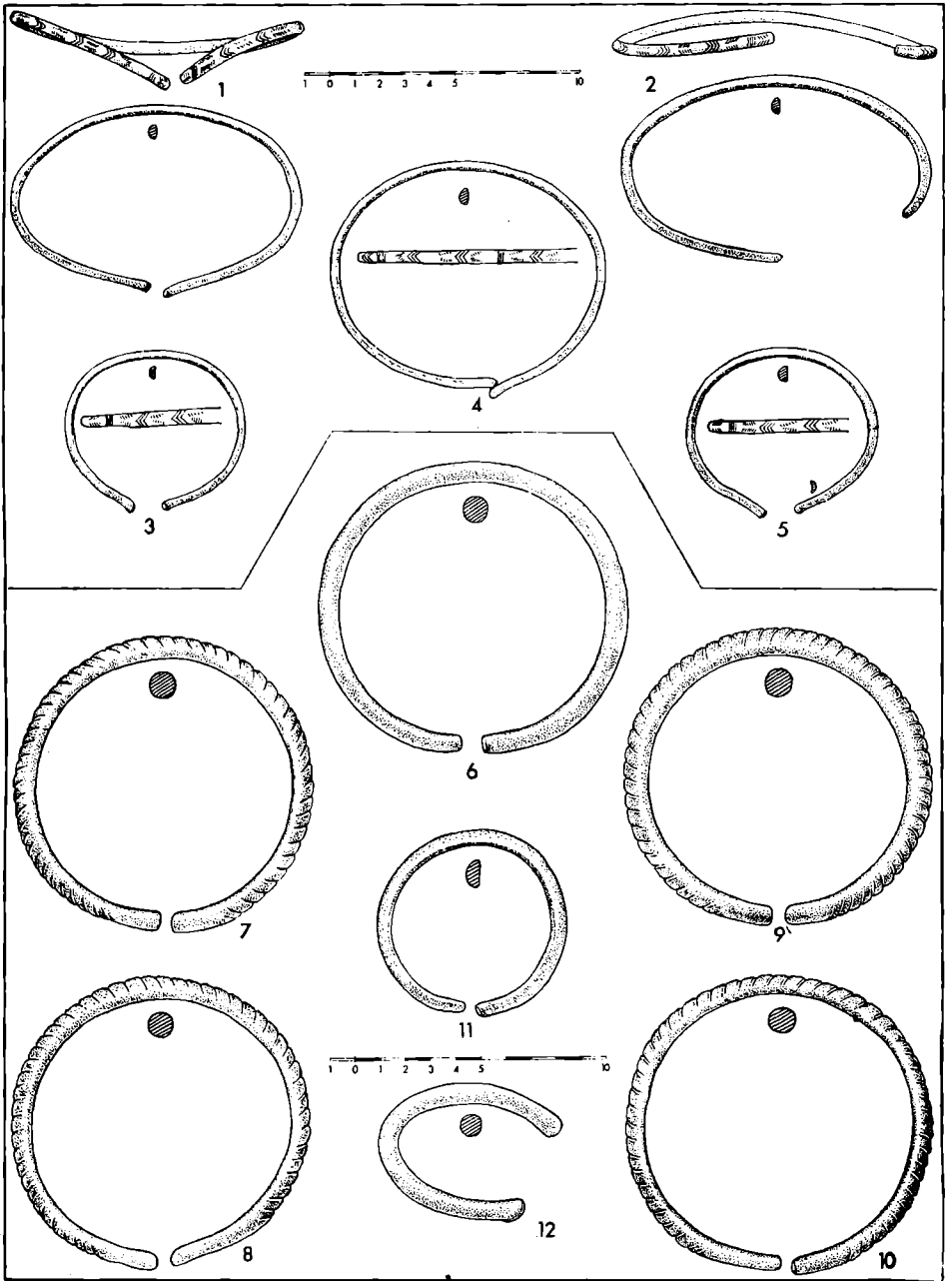

Taf. 29 — Boskovice, Bronzedepots 2 (Nr. 1–5) und 5 (Nr. 6–12)



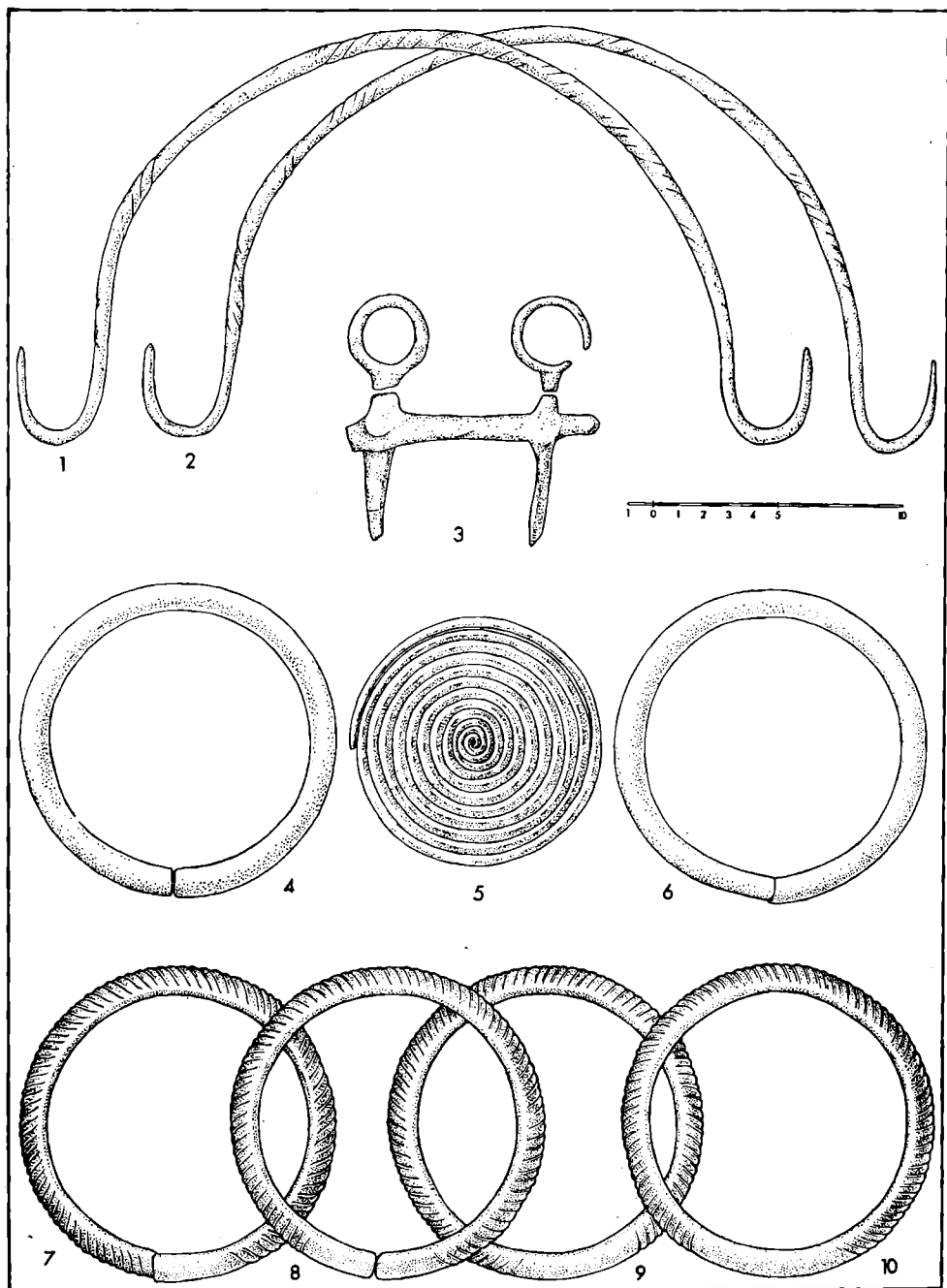

Taf. 30 — Kopřivnice, Bronzedepot

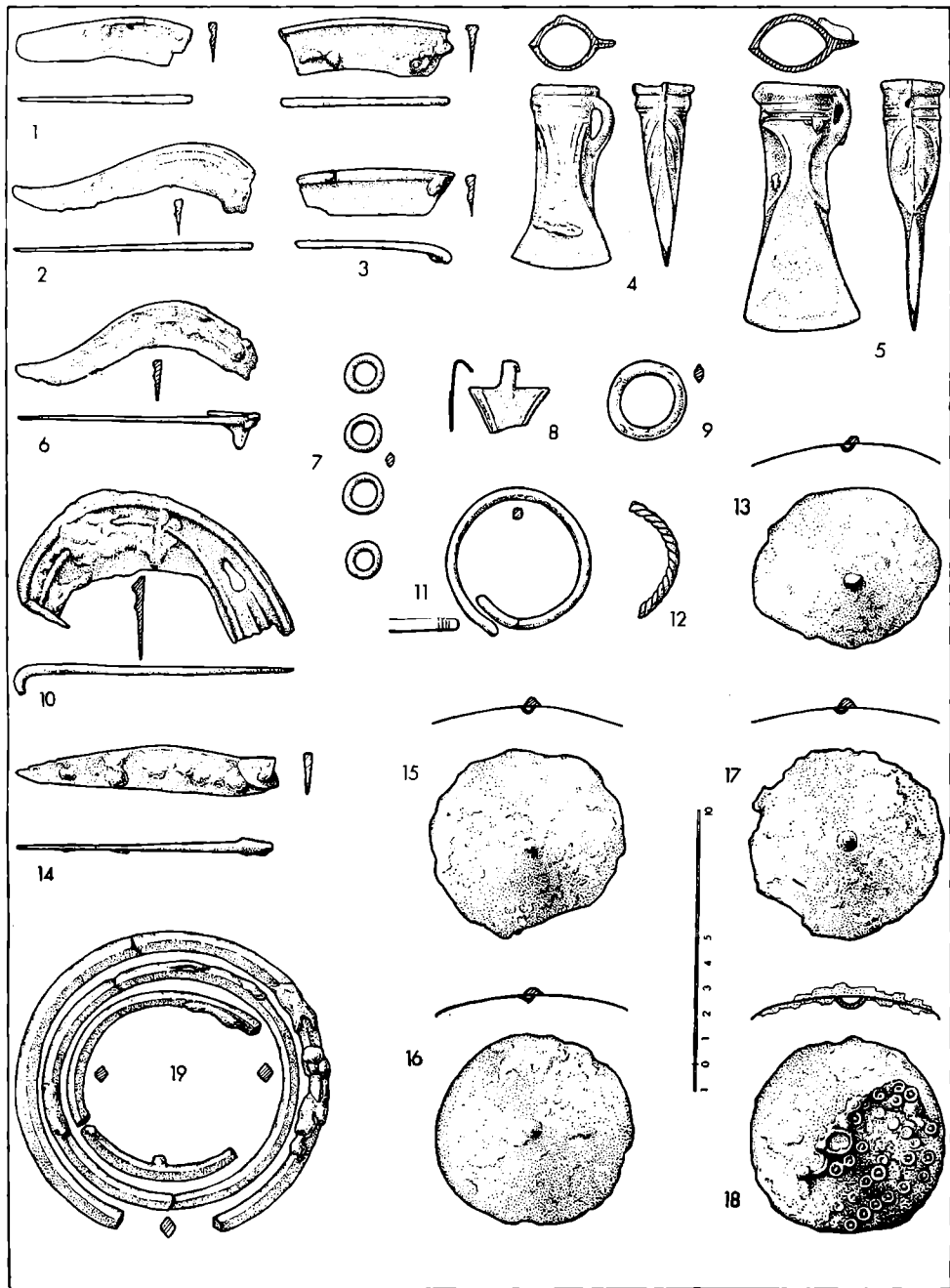

Taf. 31 — Polkovice, Bronzedeput

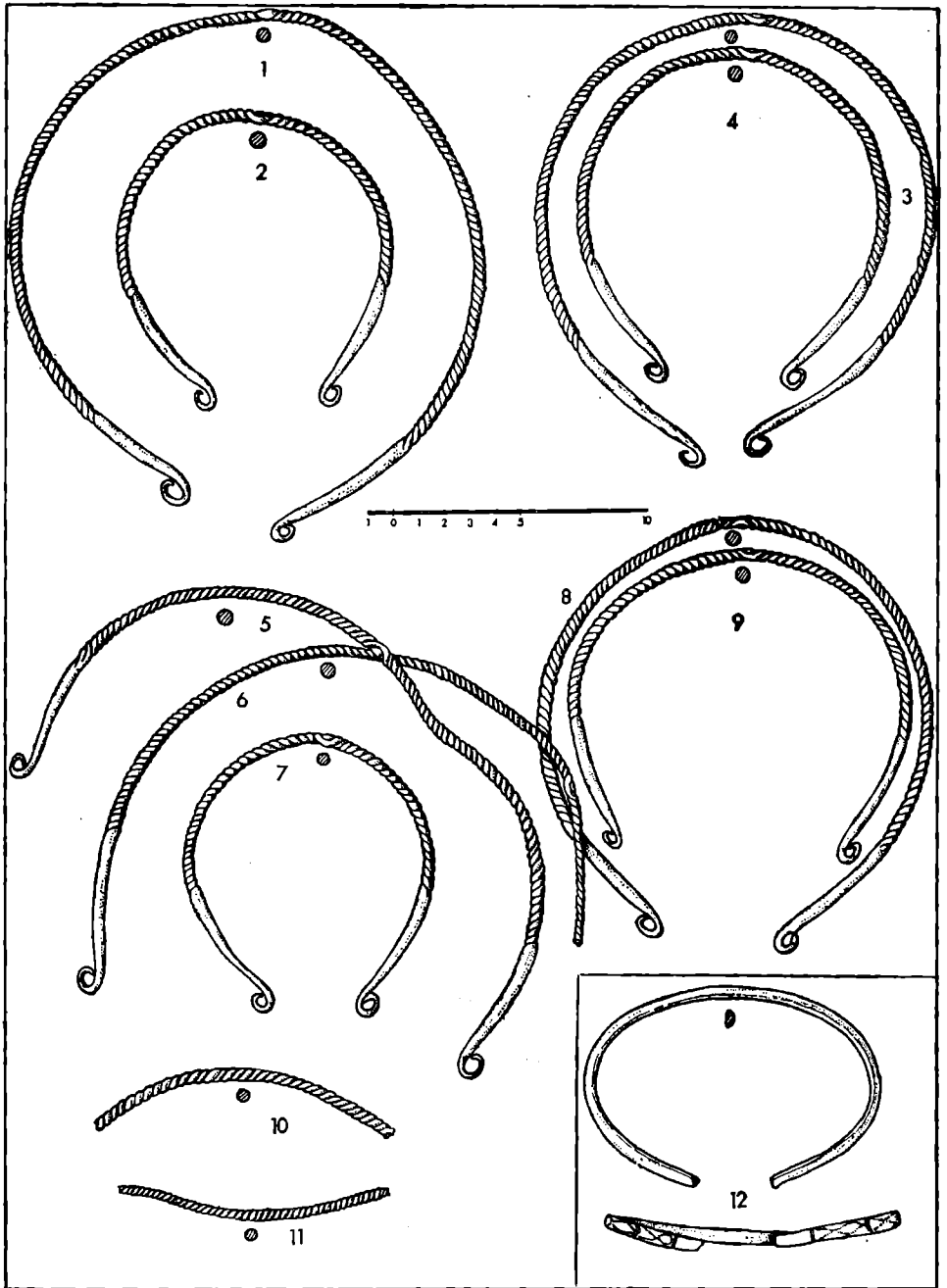

Taf. 32 — Pravčice, Bronzedepot

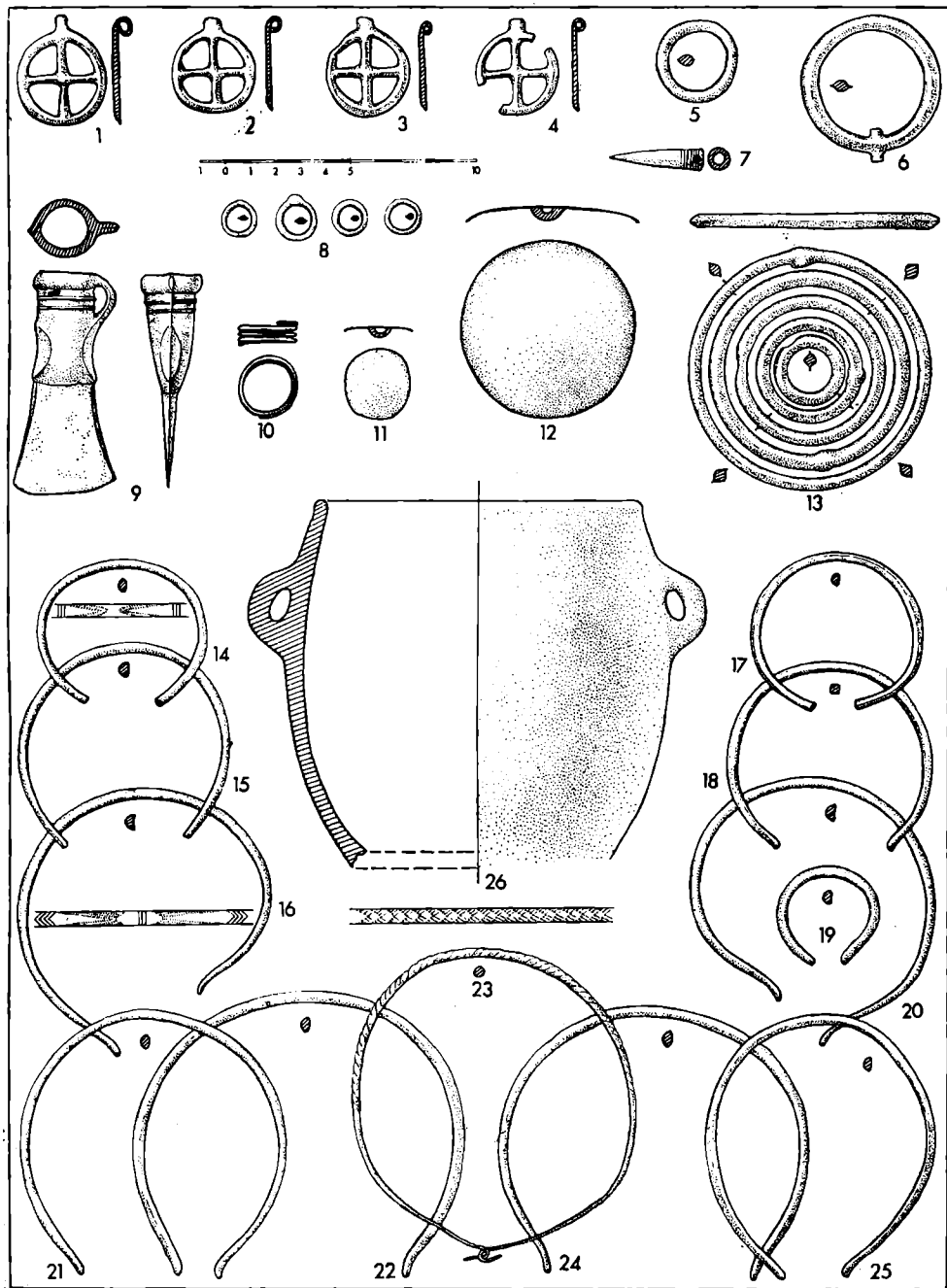

Taf. 33 — Rájec-Jestřebí, Bronzedeput

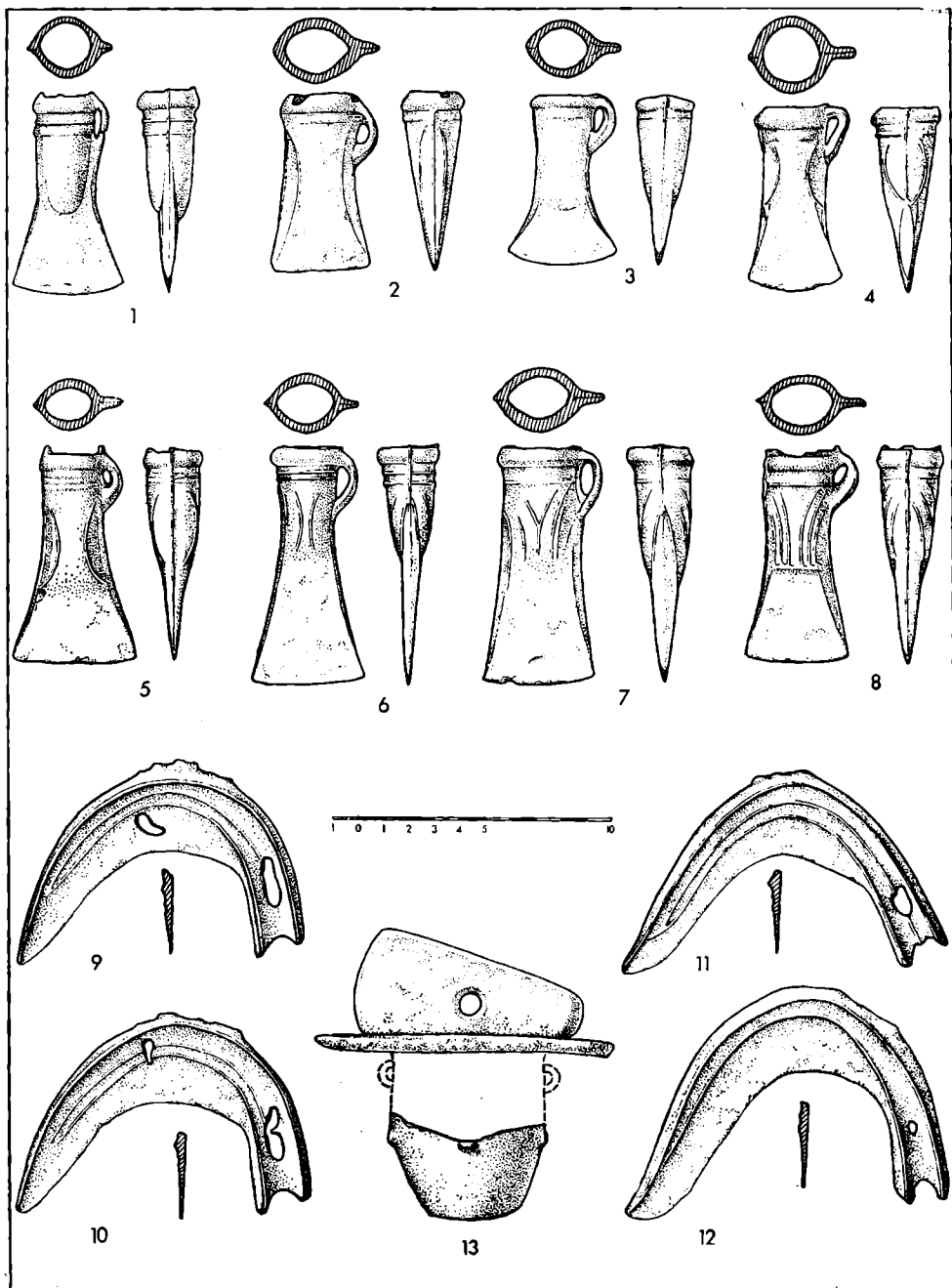

Taf. 34 — Syrovín, Bronzedeopot

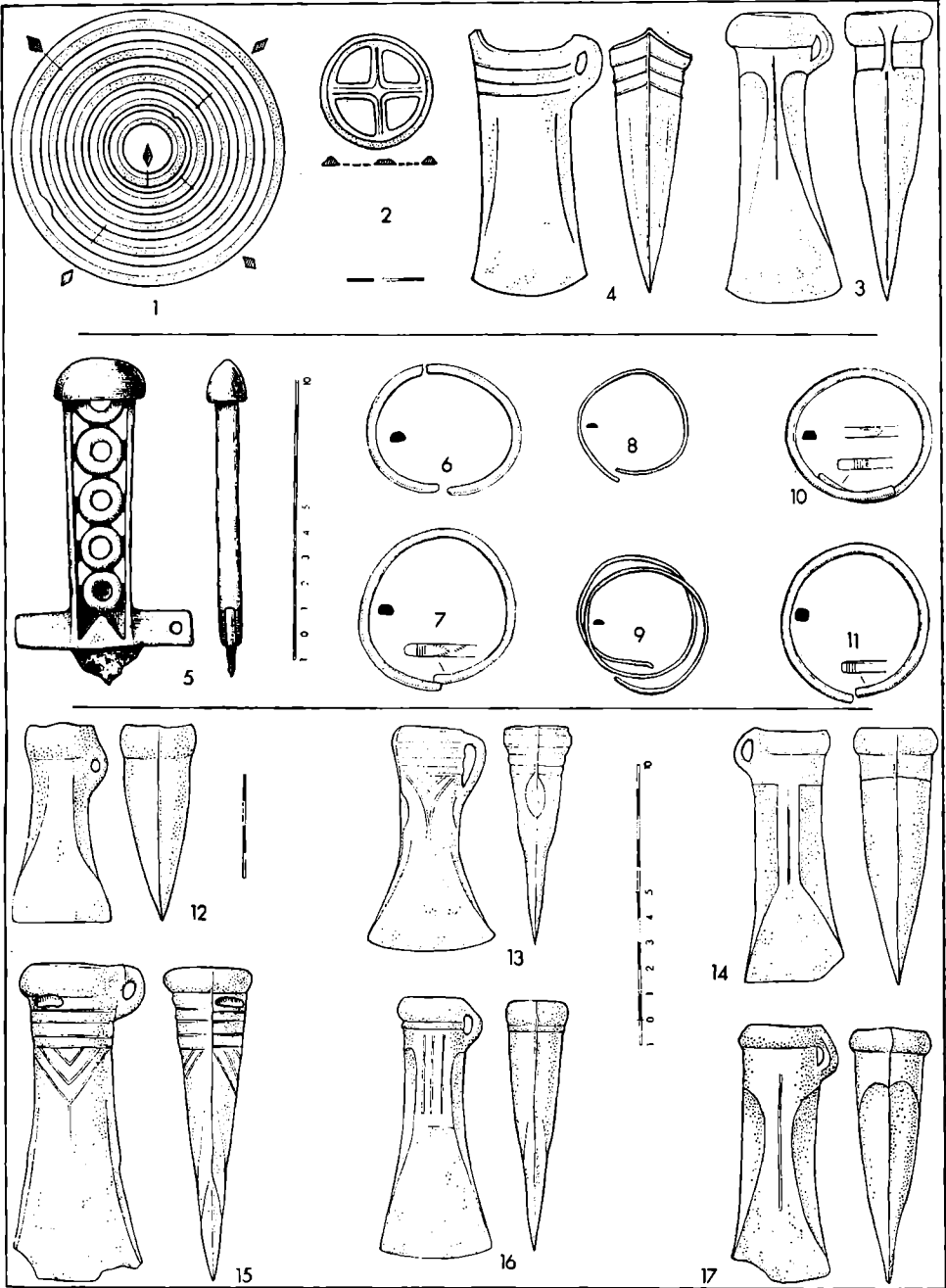

Taf. 35 — Štamberk-Kotouč, Bronzedepots 1 (Nr. 1–4) und 5 (Nr. 5–11);  
Zufallsfunde (Nr. 12–17)

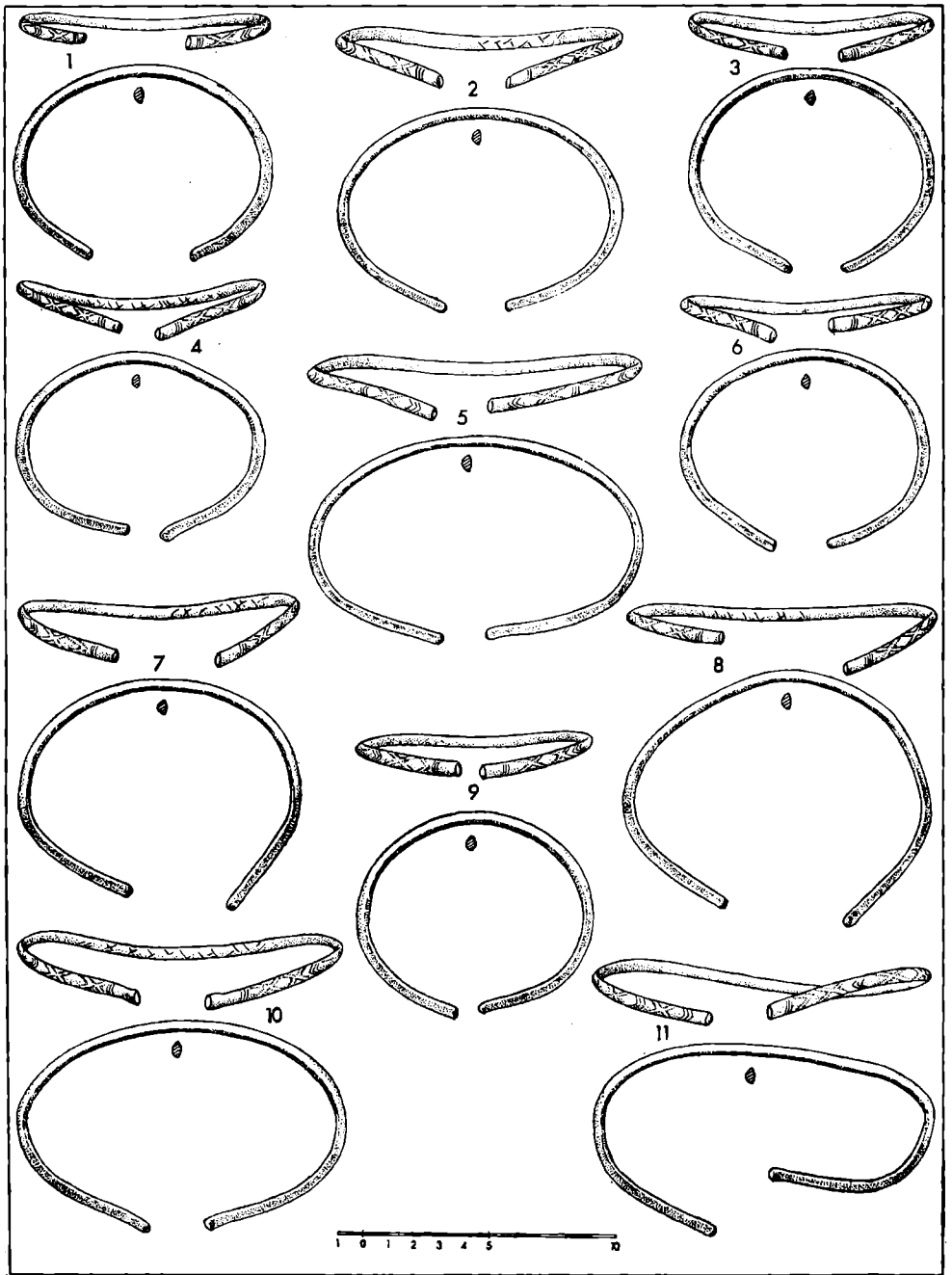

Taf. 36 — Viceměřice, Bronzedepot (1. Teil)

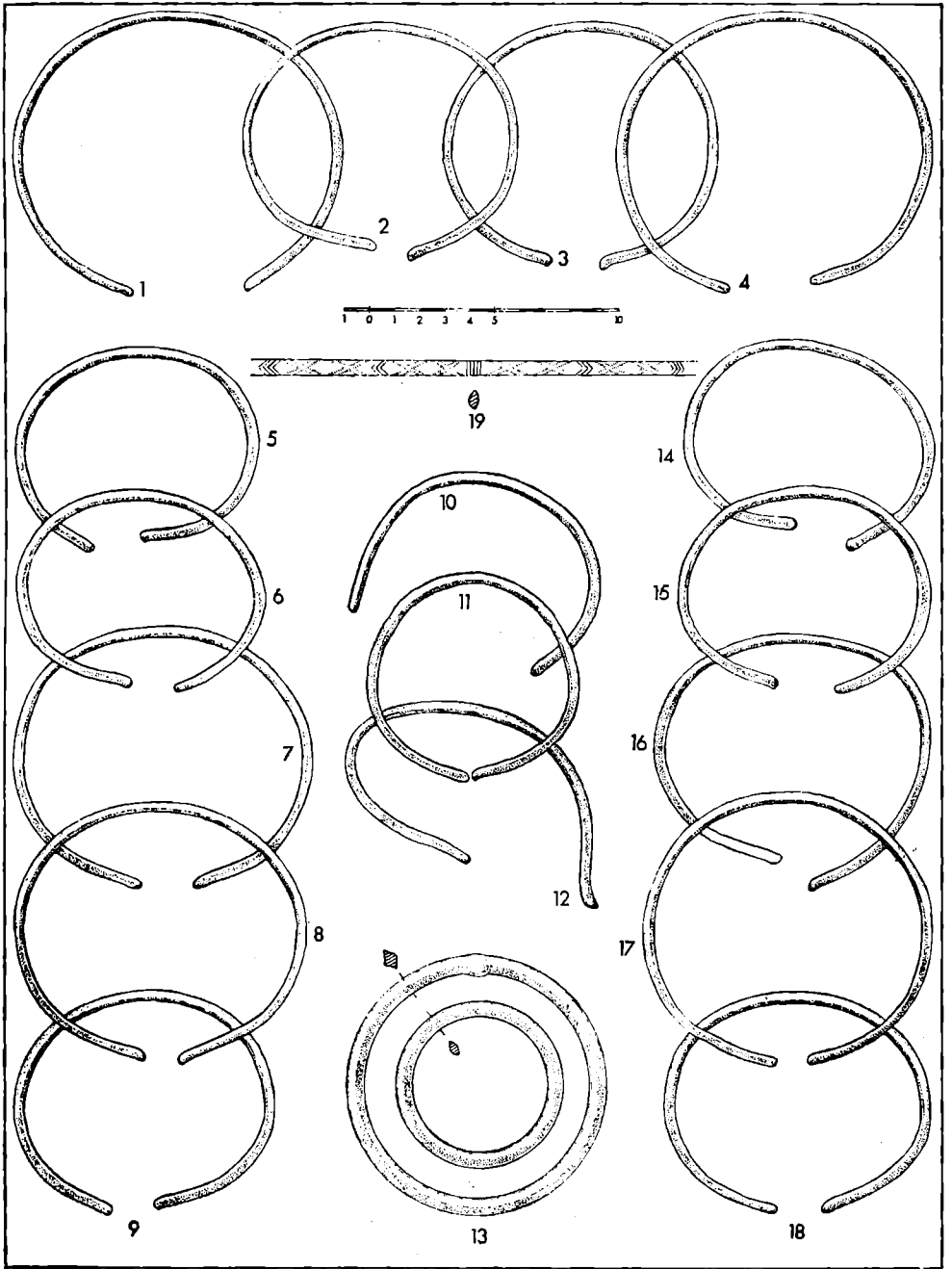

Taf. 37 — Viceměřice, Bronzedepot (2. Teil)



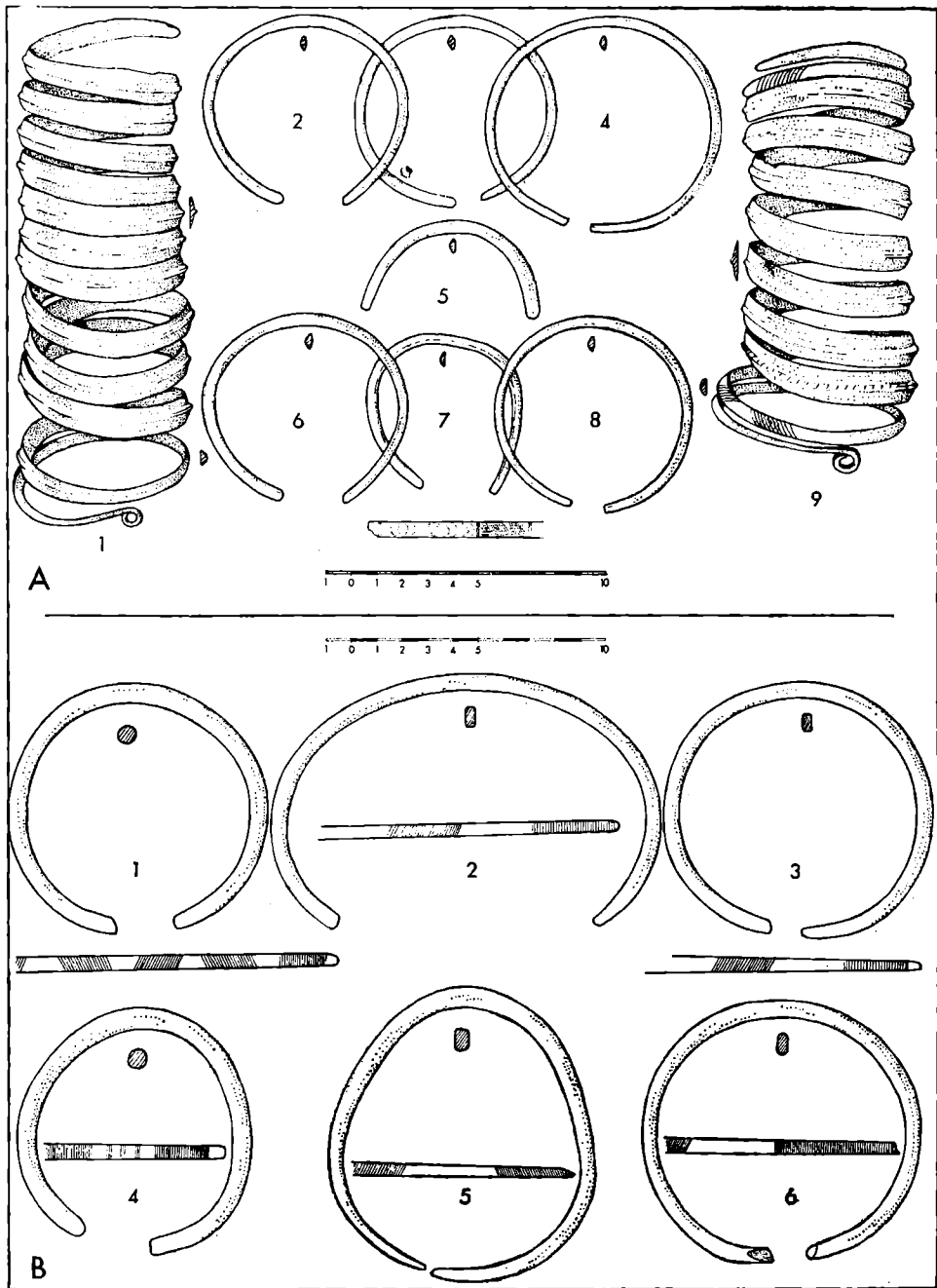

Taf. 38 — A — Zádvěřice, Bronzedepot; B — Žárovice, Bronzedepot 1

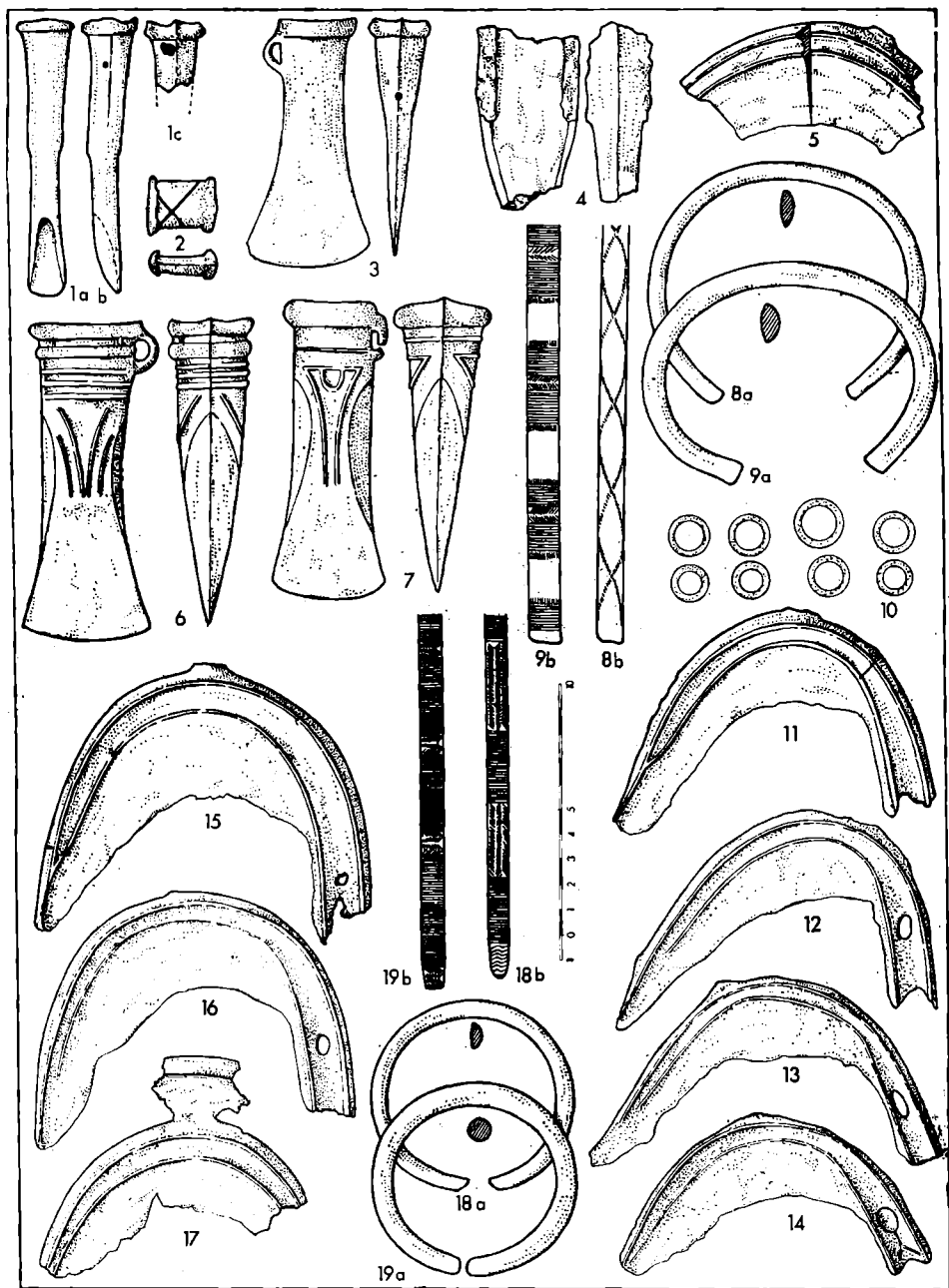

Taf. 39 — 1-9 — Žárovice, Bronzedepot 2; 10-14 — Überreste aus Bronzedepots 1 und 2 aus Bílovice; 15 — Mostkovice; 16-17 — Drahanovice, Bronzedepot 1; 18-19 — Drahanovice, Bronzedepot 2

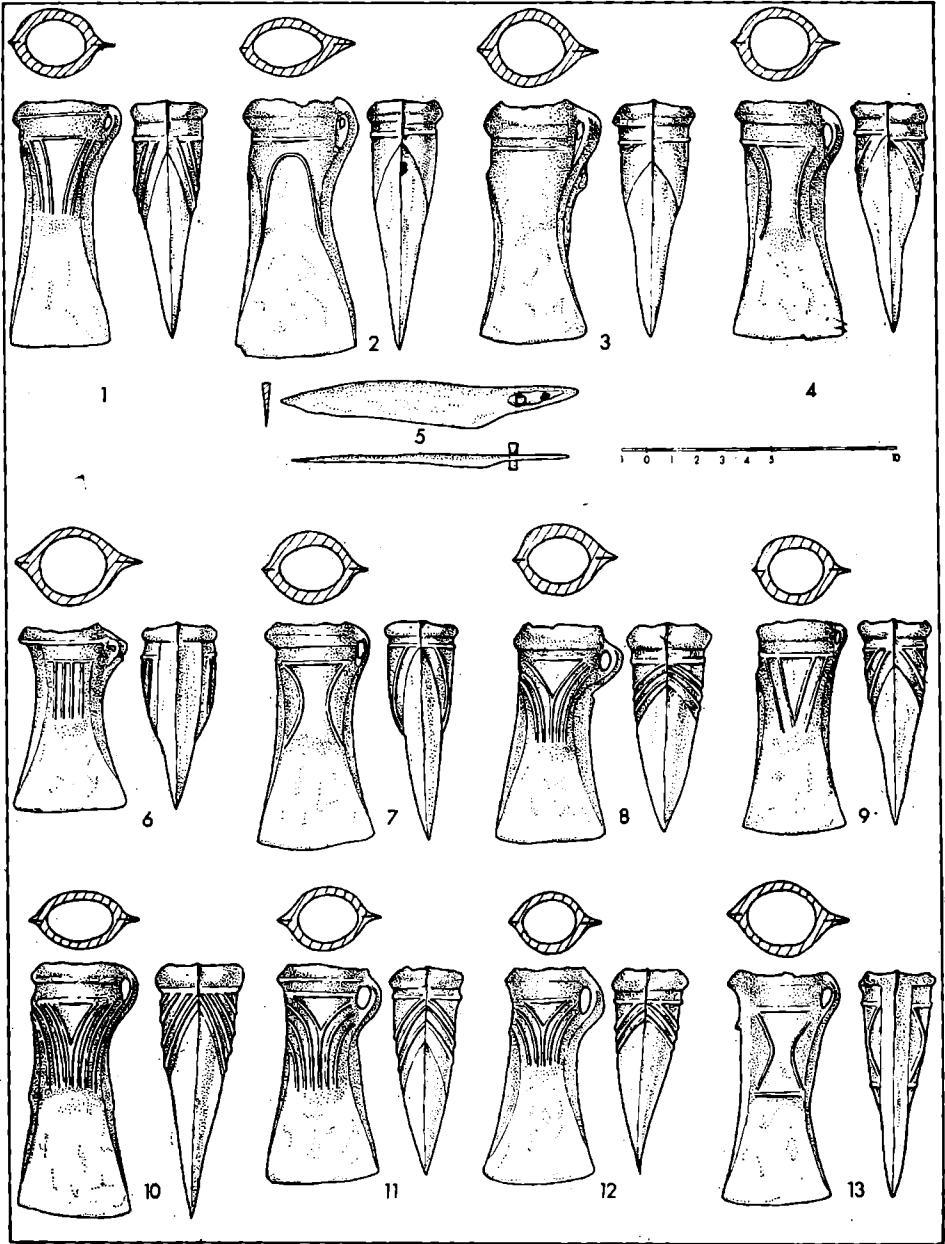

Taf. 40 — Marefy, Bronzedept

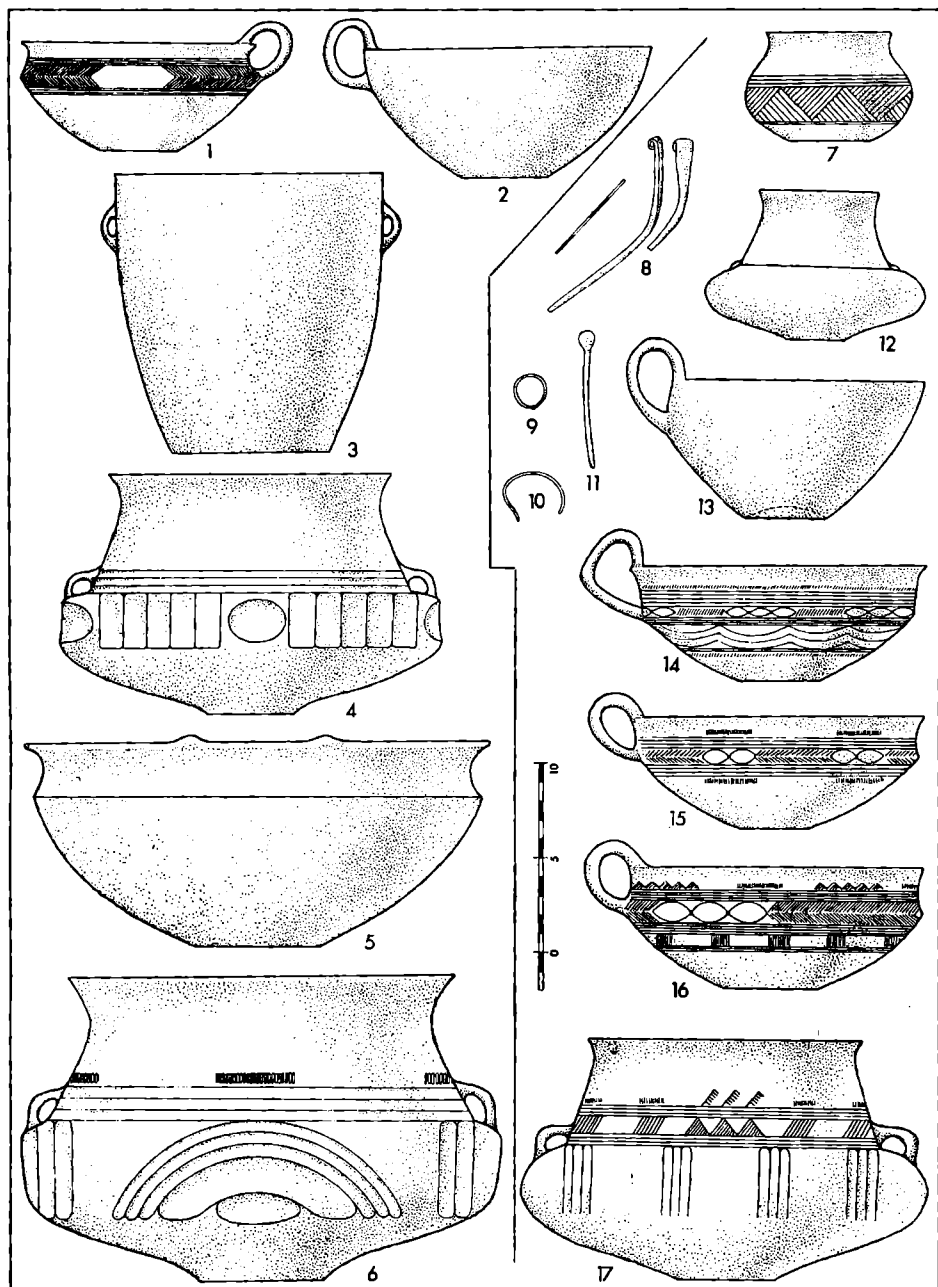

Taf. 41 — Čelechovice, Grab 3 (Nr. 1–6) und Grab 14 (Nr. 7–17)

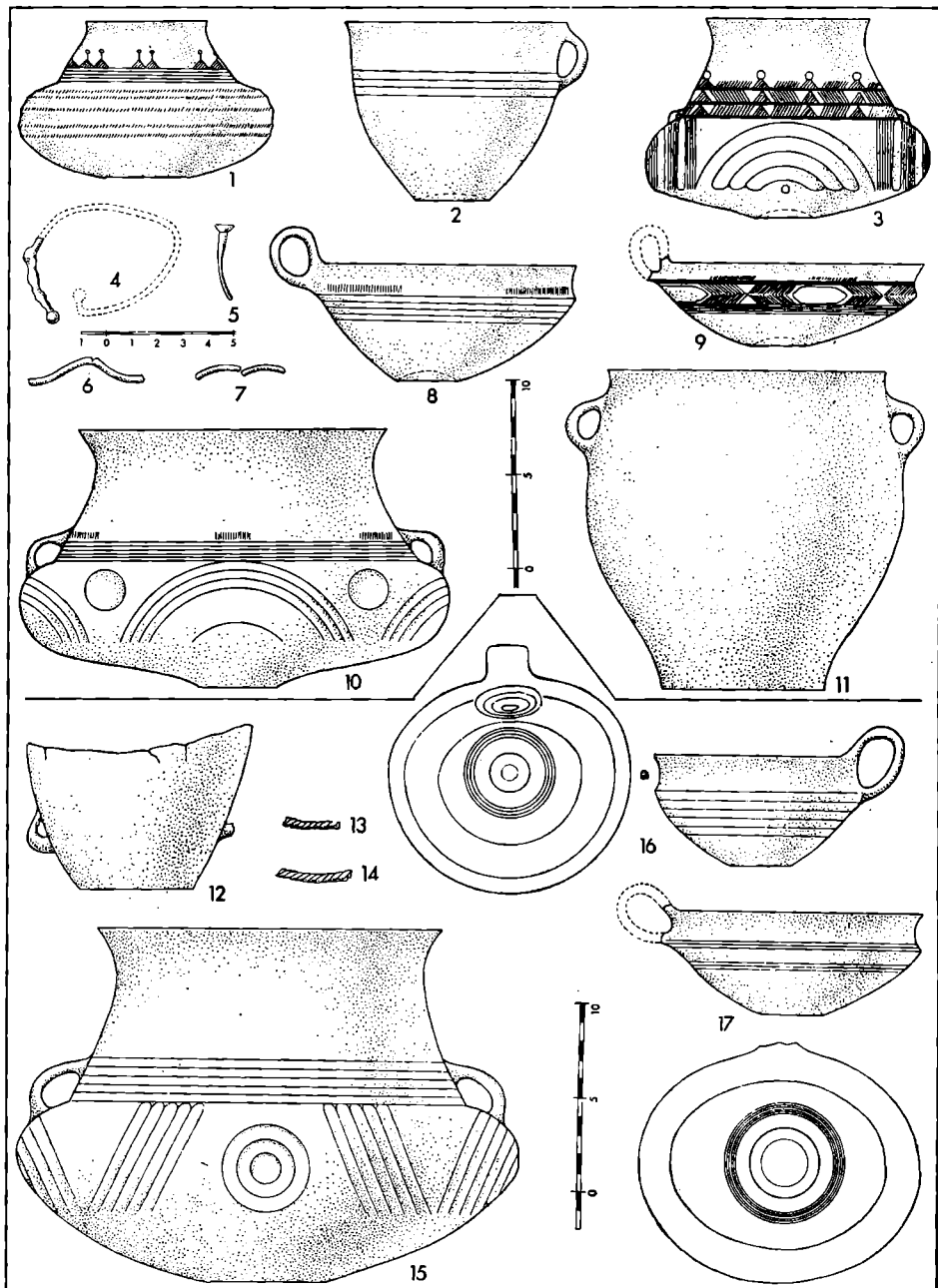

Taf. 42 — Domamyslice, Grab 41 (Nr. 1—11) und 207 (Nr. 12—17)

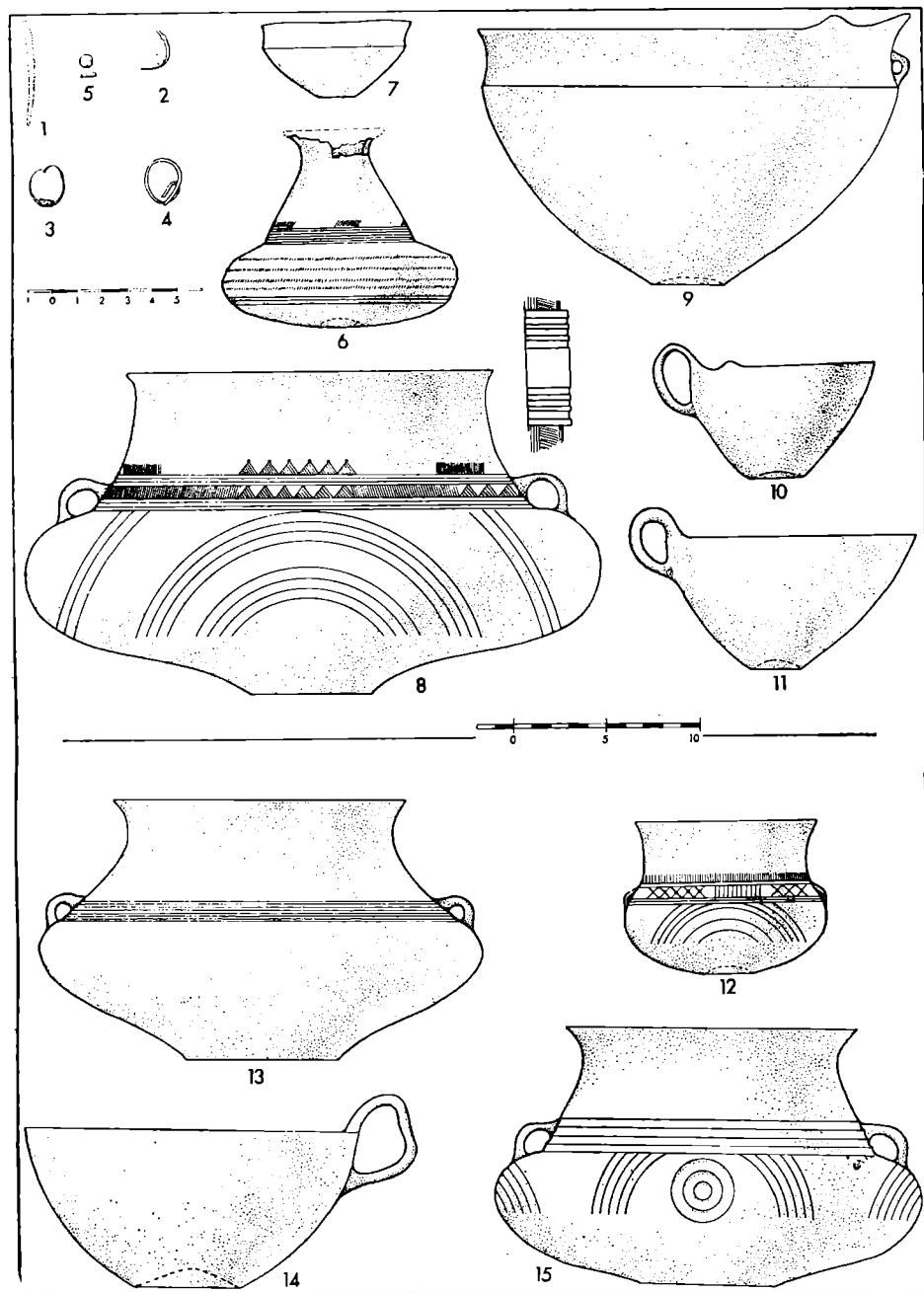

Taf. 43 — 1–11 — Domamyslice, Grab 59; 12 — Domaželice; 13 — Moravská Hůzová; 14–15 — Tršice

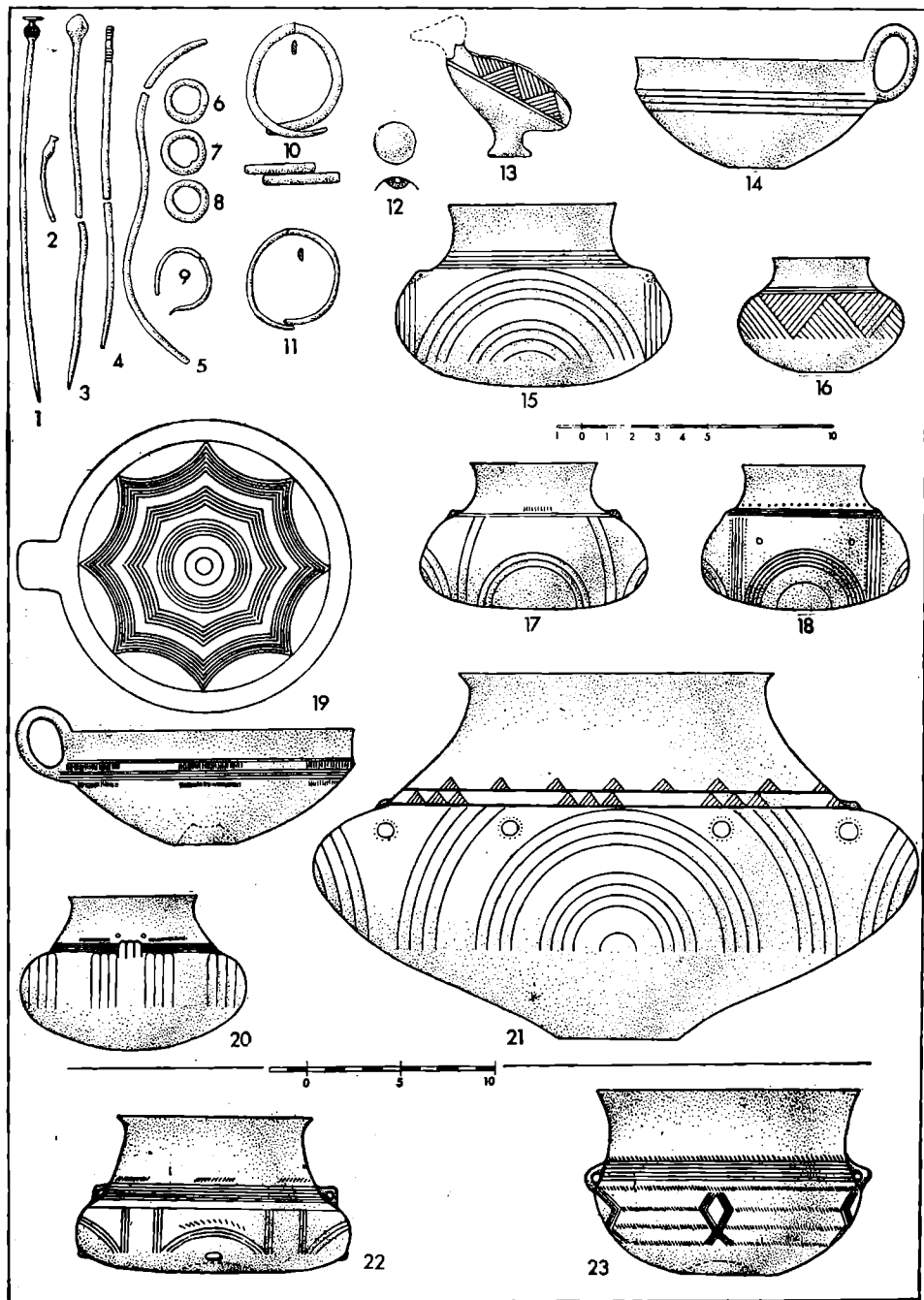

Taf. 44 — 1-21 — Domamyslice, Grab 152; 22 — Boskovice; 23 — Ptení

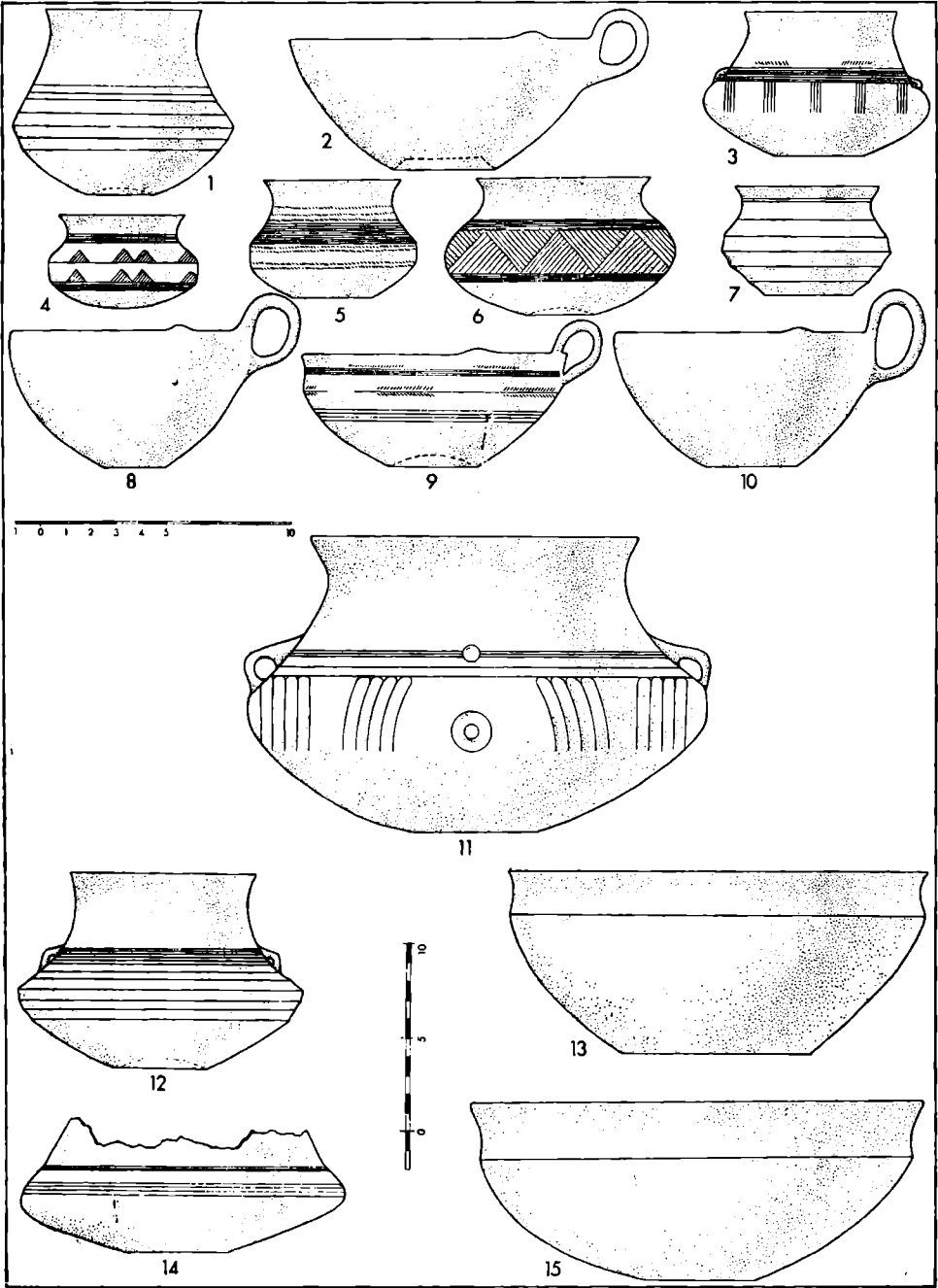

Taf. 45 — Horka nad Moravou, Grab B XLVIII



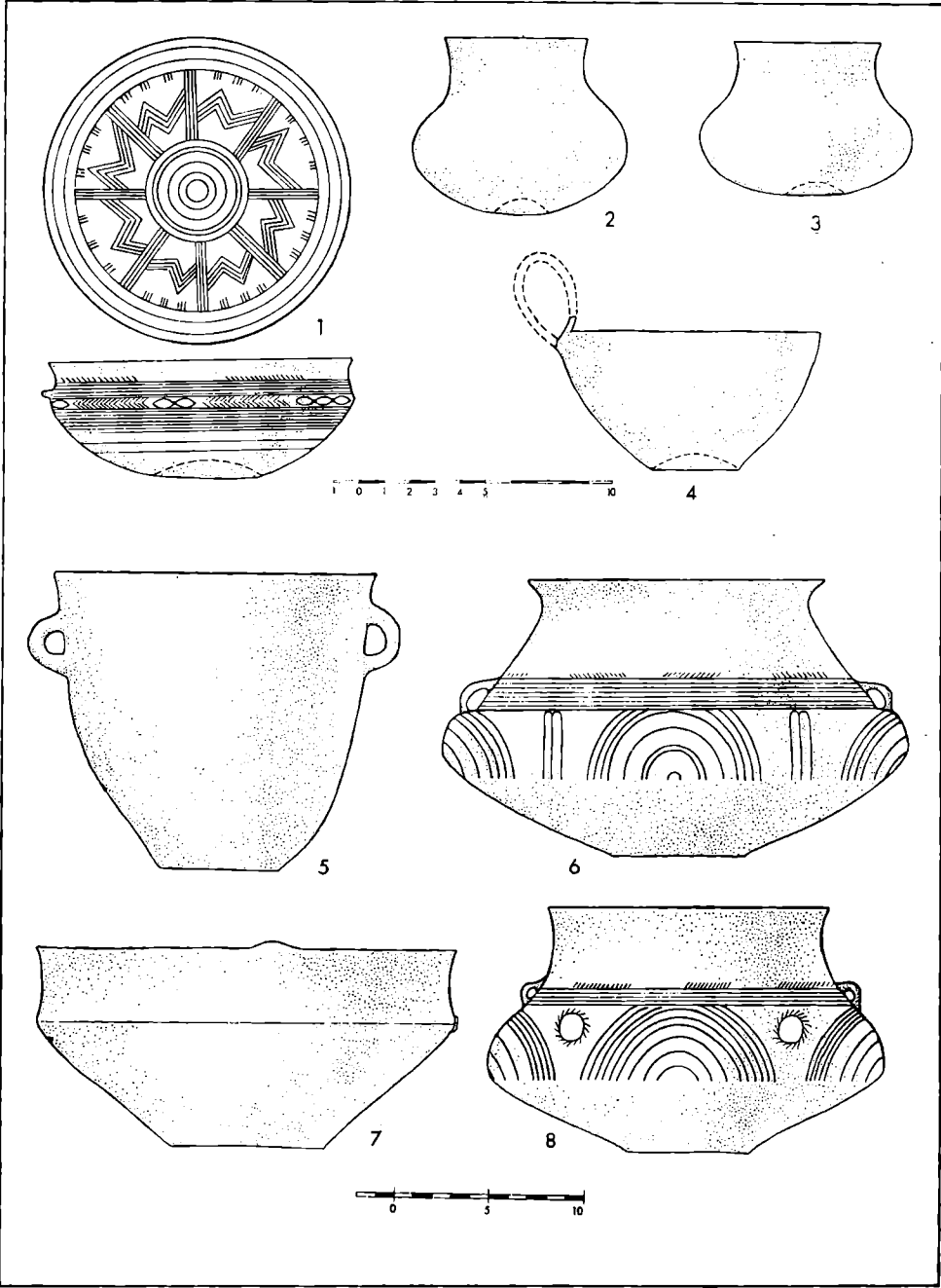

Taf. 46 — Mohelnice, Grab VI

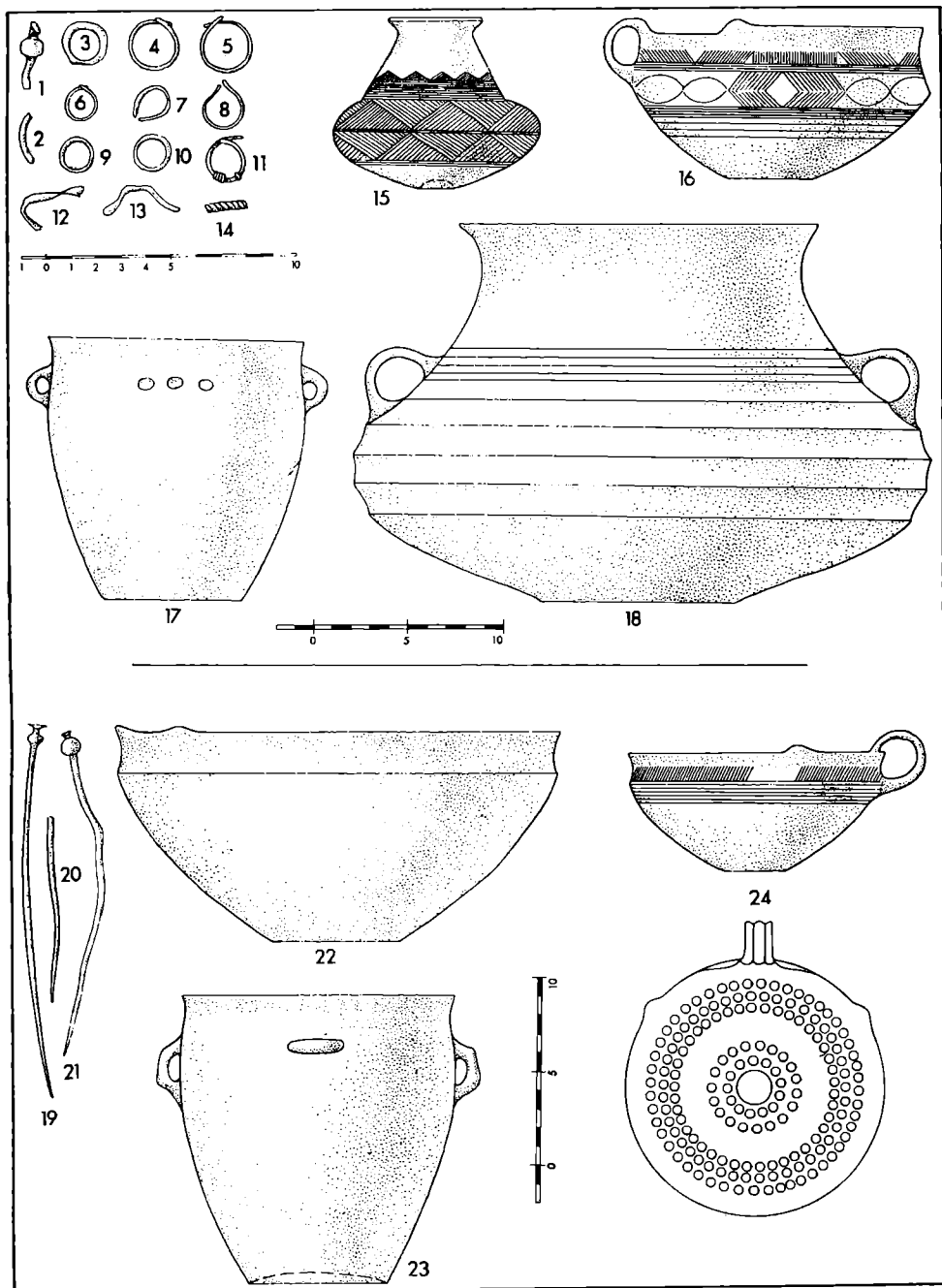

Taf. 47 — Slatinky, Grab 16 (Nr. 1–18) und Grab 37 (Nr. 19–24)

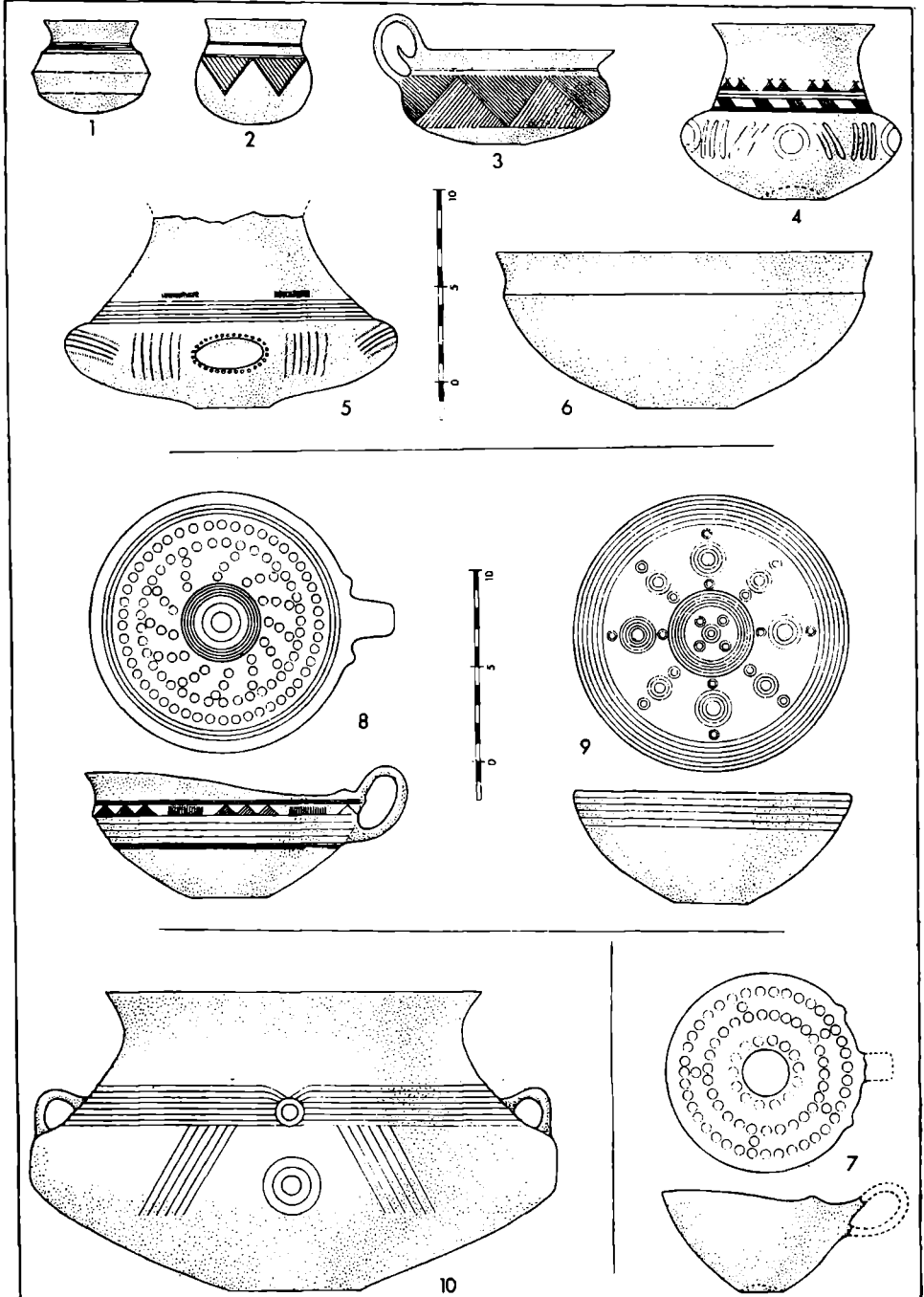

Taf. 48 - 1-6 - Tišnov, Grab 19; 7 - Krumstín; 8-9 - Určice, Grab 138; 10 - Určice, Grab 79

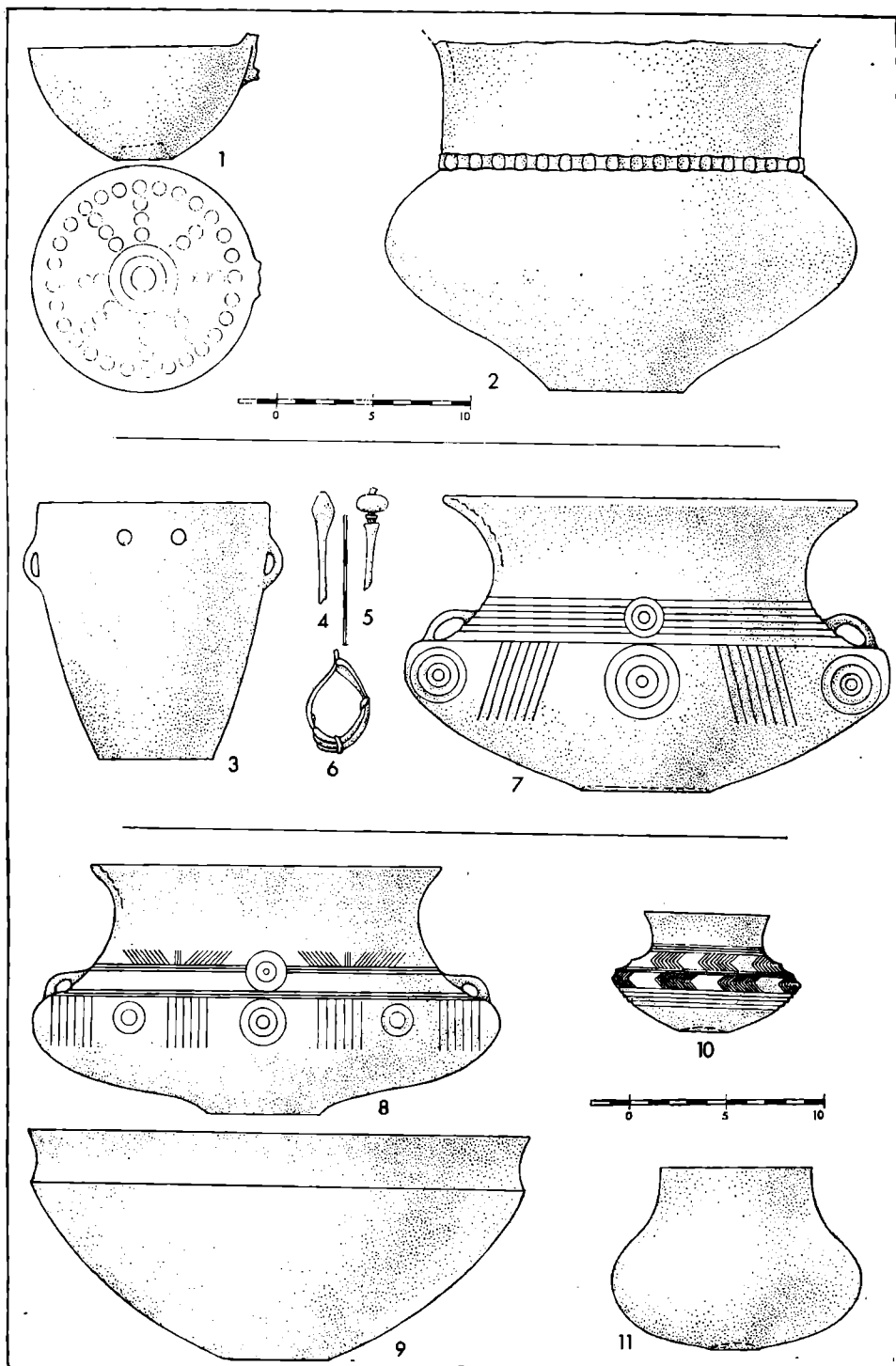

Taf. 49 — Určice, Grab 118 (Nr. 1–2); Grab 216 (Nr. 3–7); Grab 263 (Nr. 8–11)

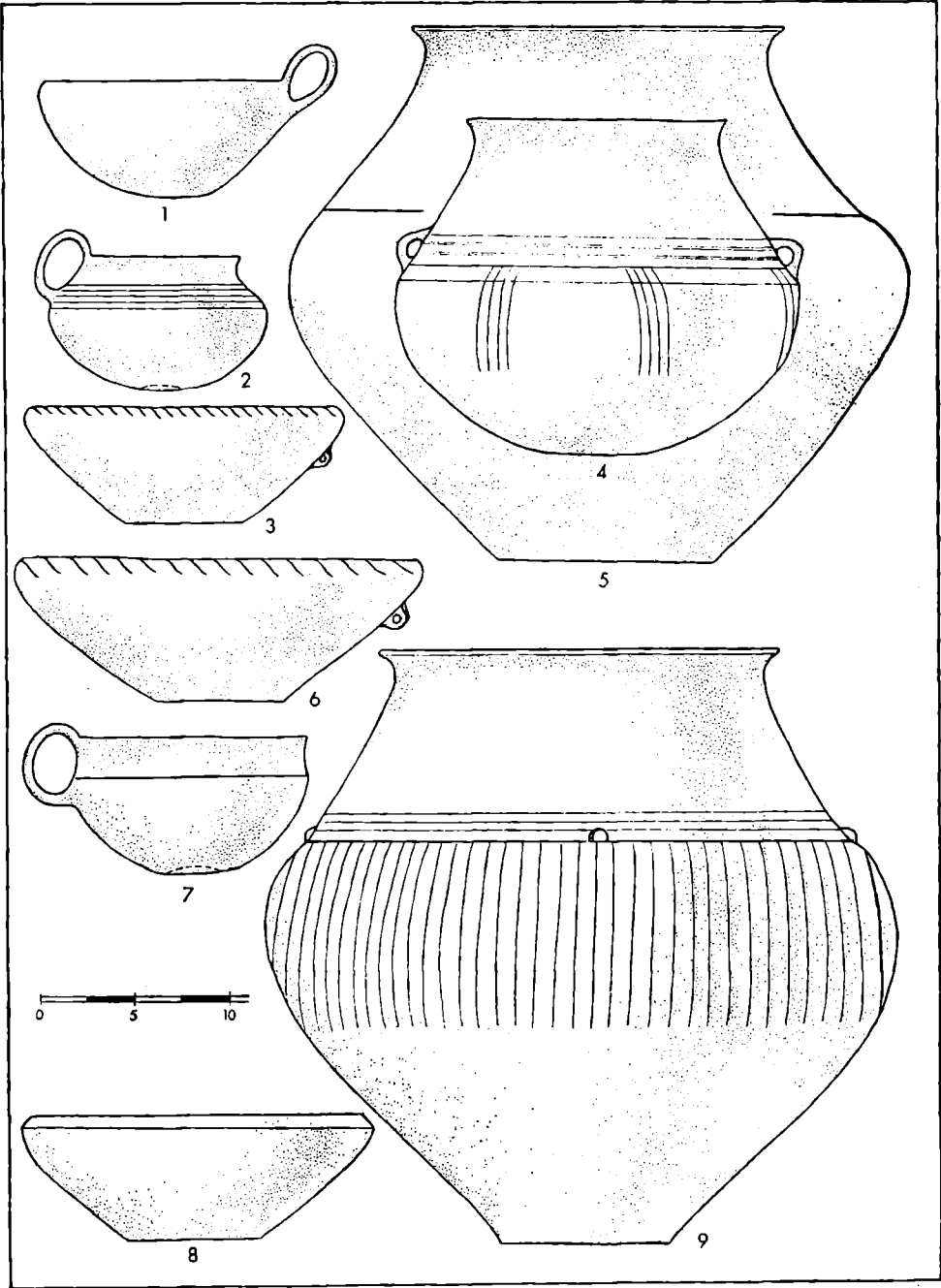

Taf. 50 — Brno-Obřany, Grab 135

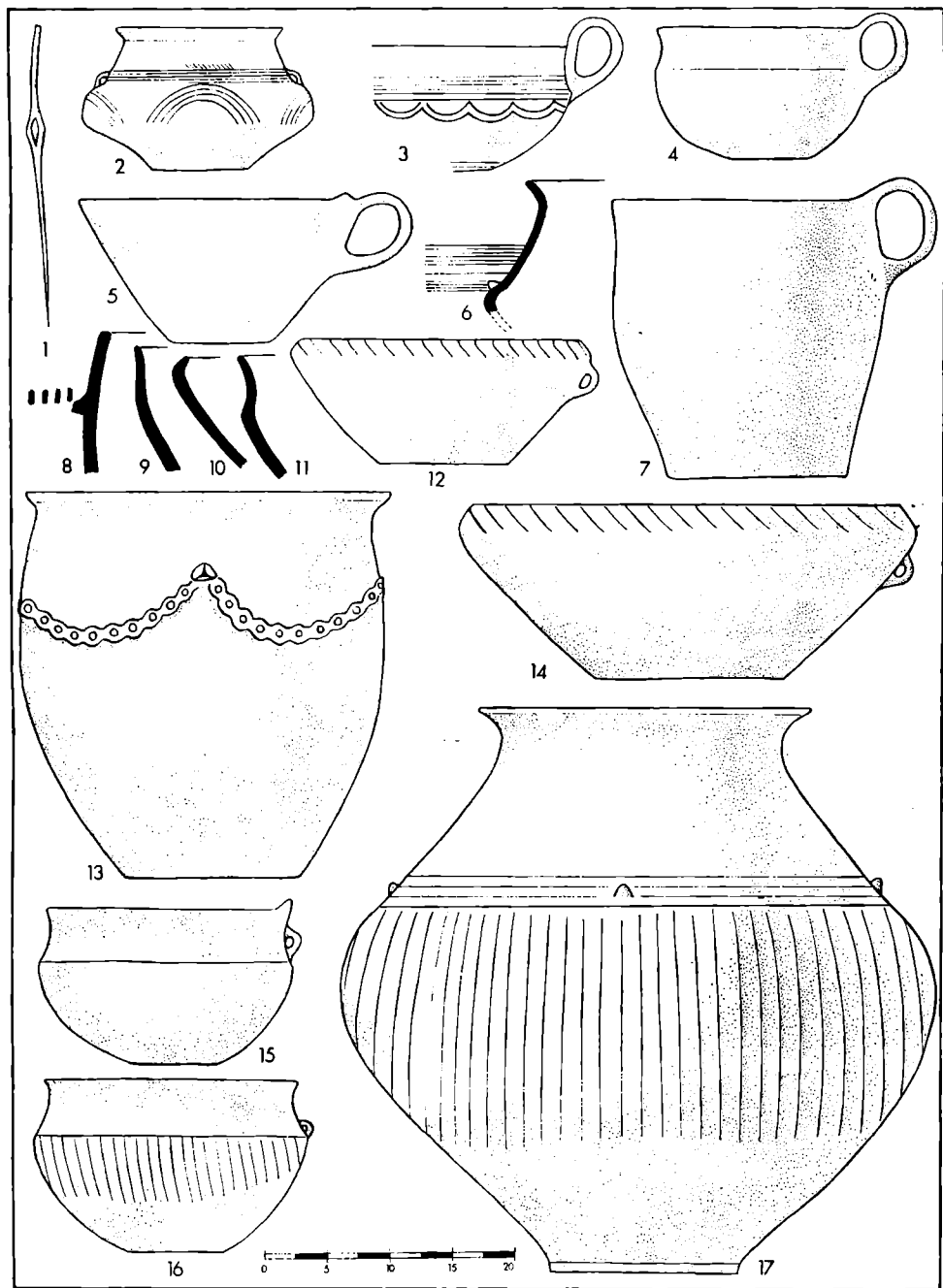

Taf. 51 — Brno-Obřany, Objekt LXX

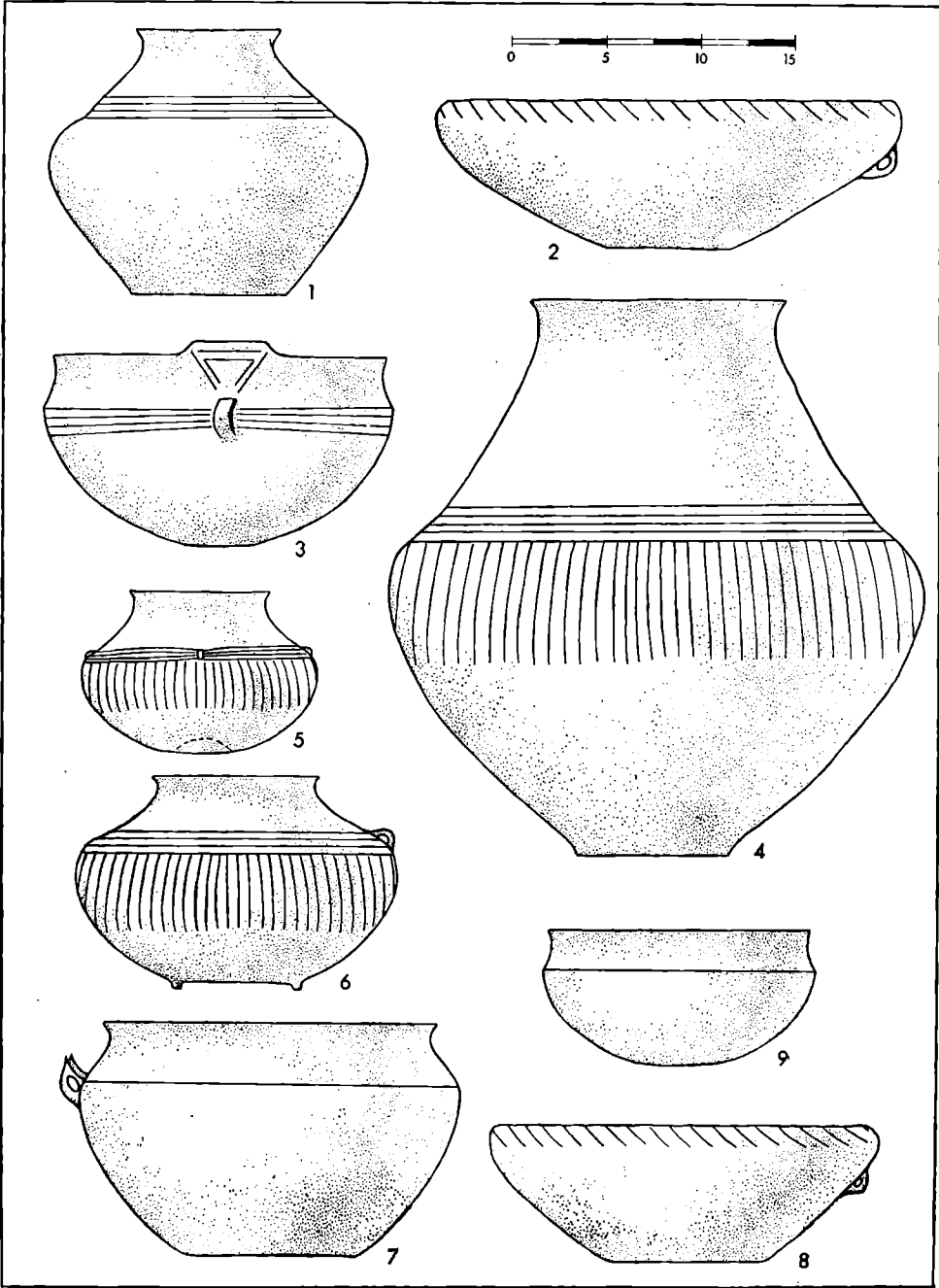

Taf. 52 — Podolí, aus verschiedenen Gräbern

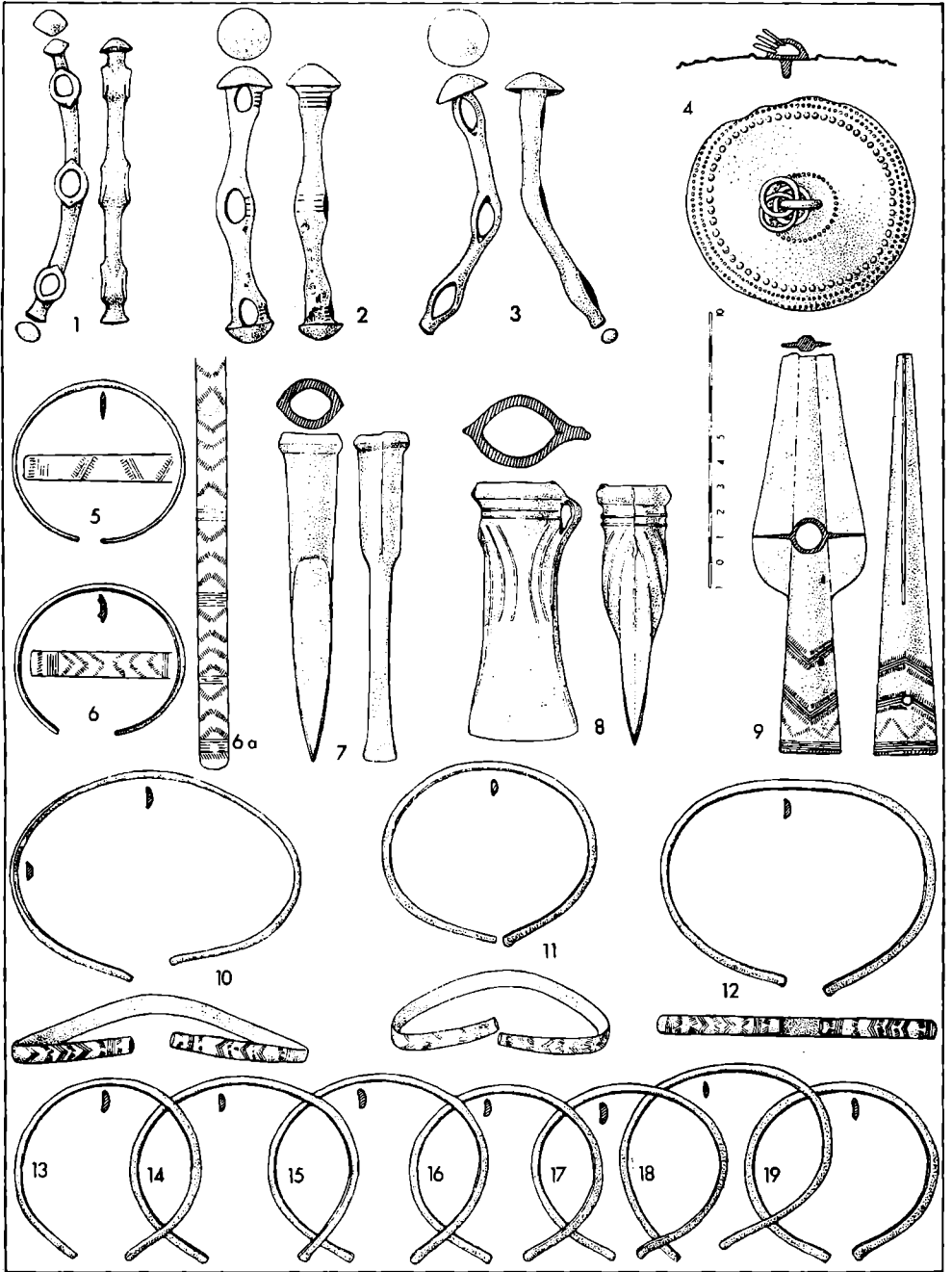

Taf. 53 — Černotín, Bronzedeopot



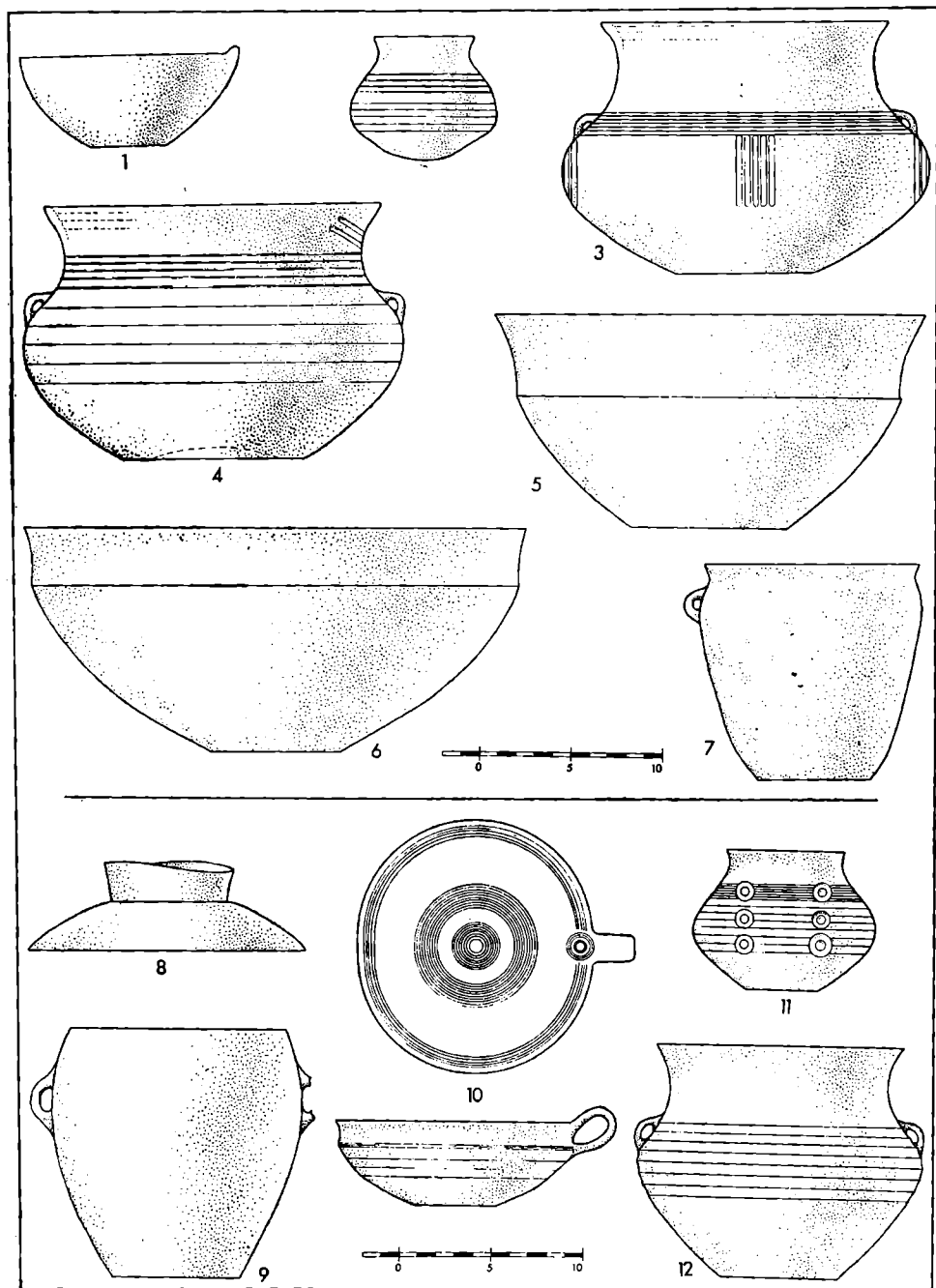

Taf. 54 — 1—7 — Mohelnice, Grab X; 8—12 — Horka nad Moravou, Grab B XXVII

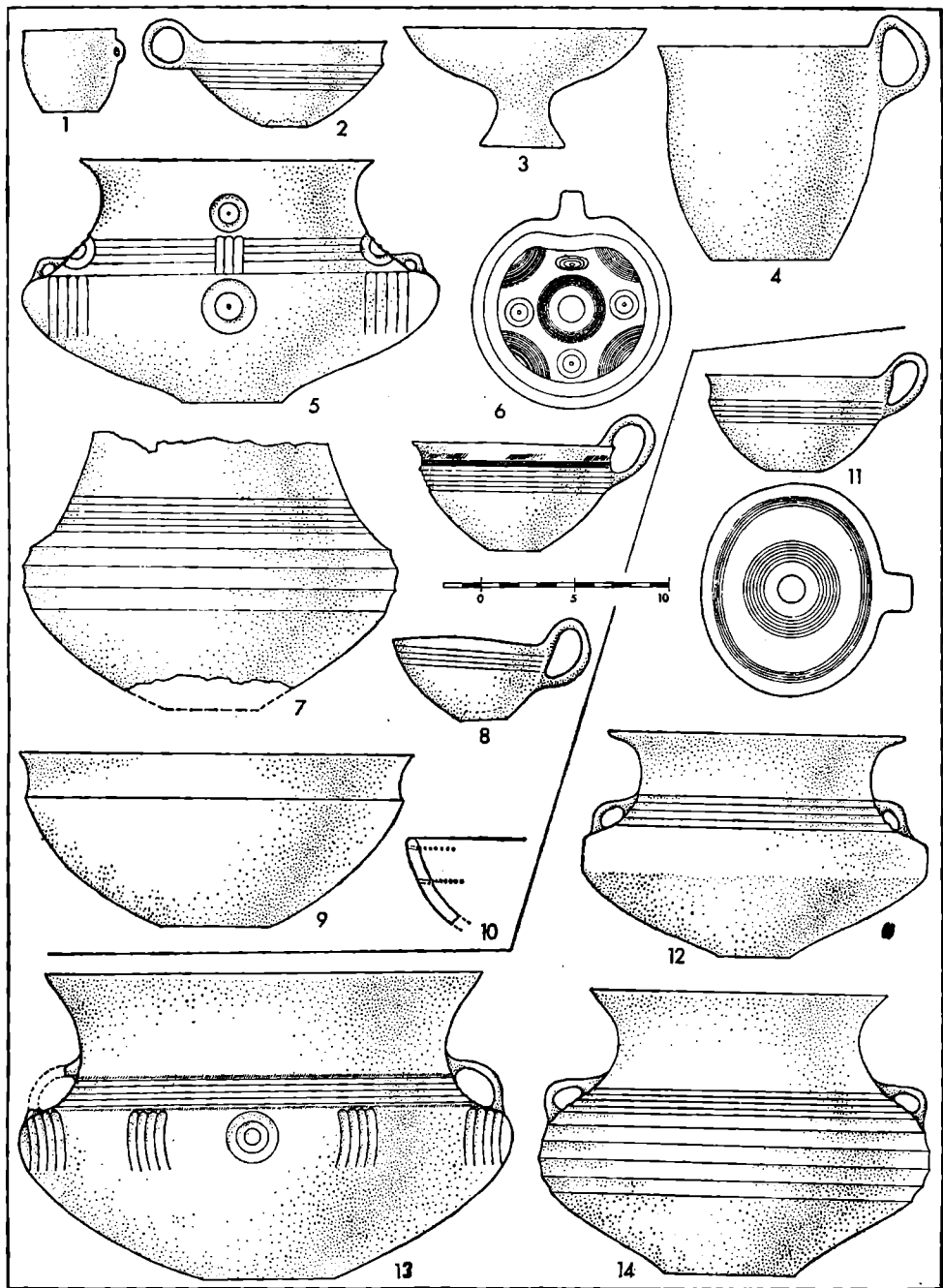

Taf. 55 — Ptení, Grab 1 (Nr. 1–10); Grab 3 (Nr. 11–14)

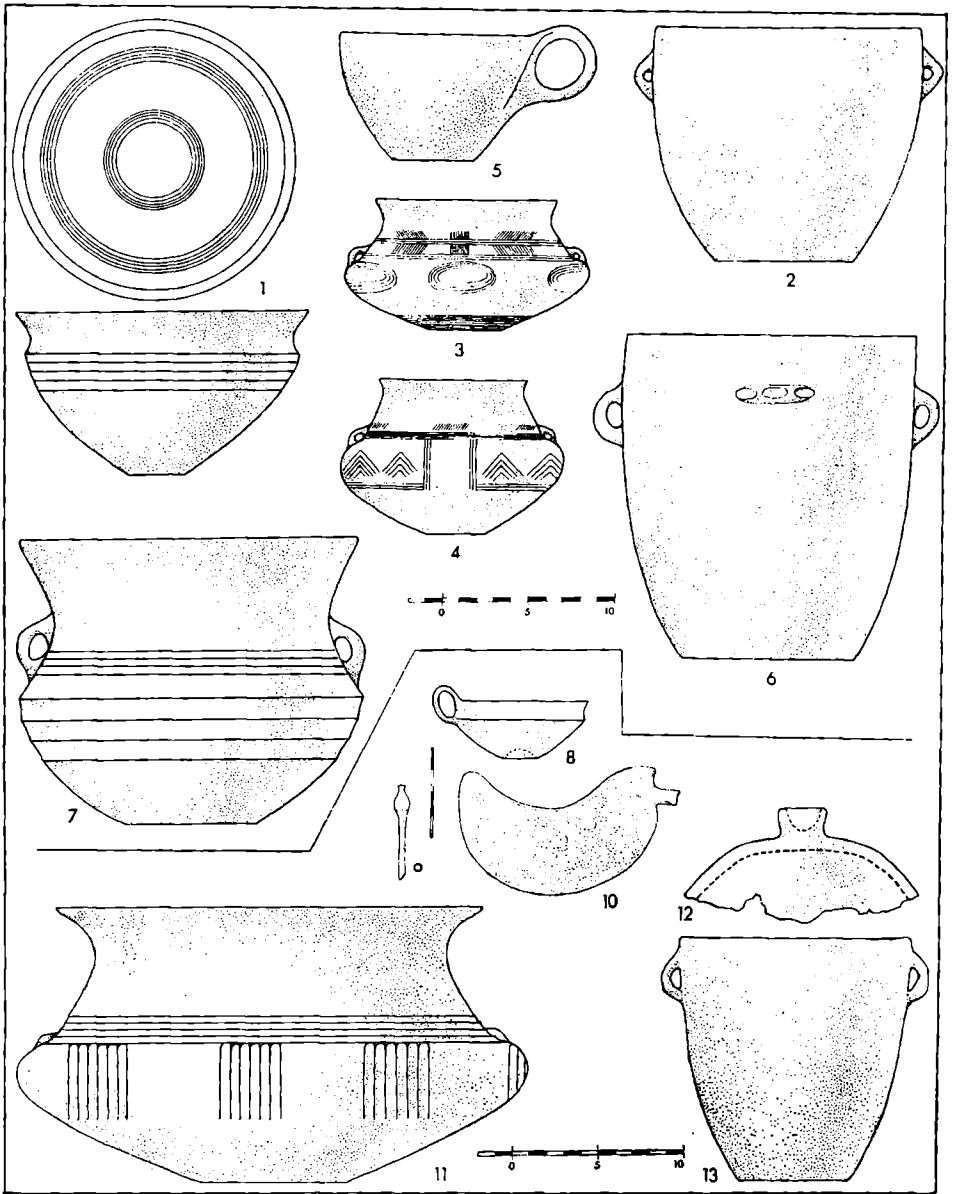

Taf. 56 — 1-7 — Horka nad Moravou, Grab B IX; 8-13 — Určice, Grab 220

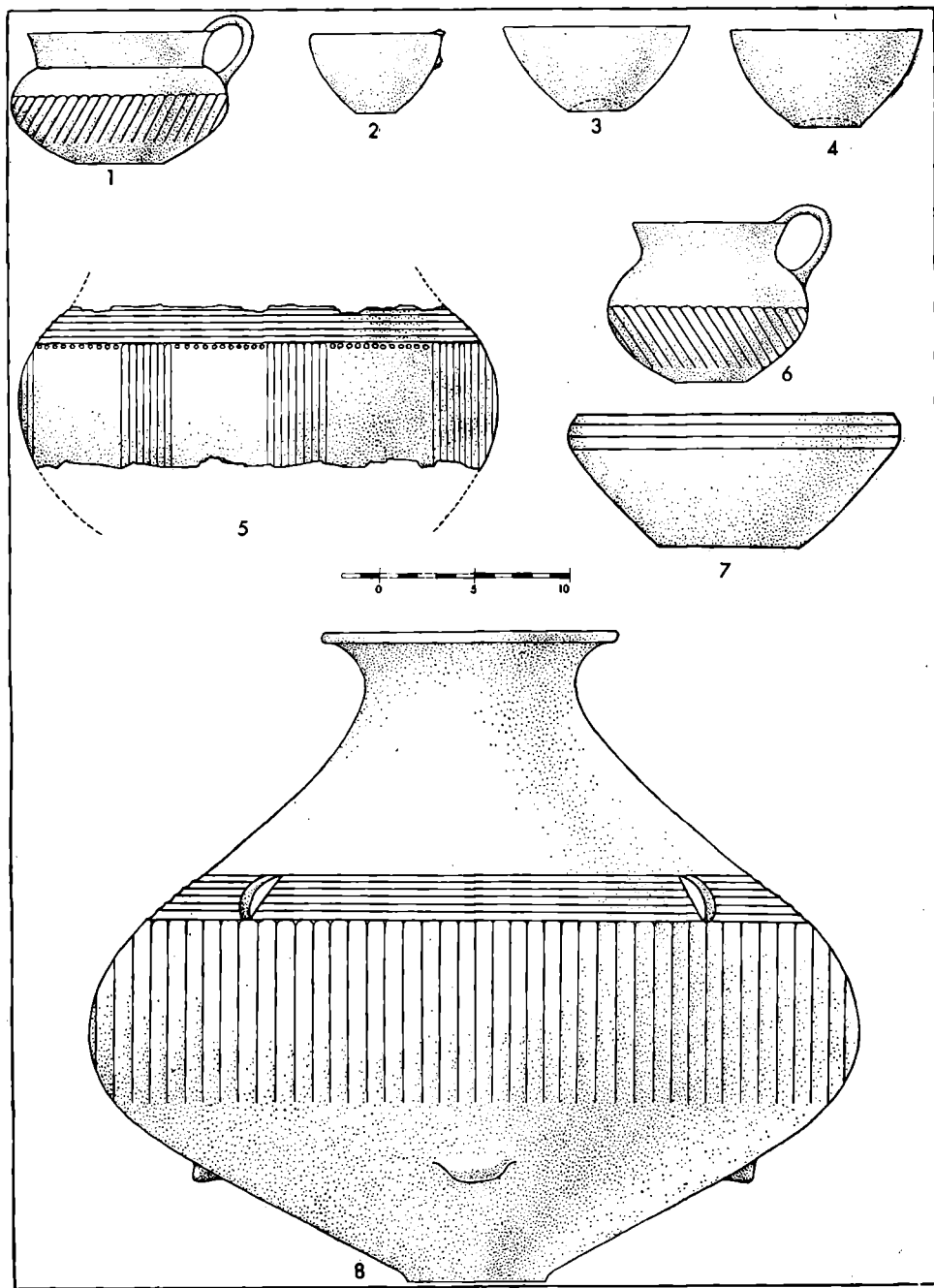

Taf. 57 — Klentnice, Grab 24

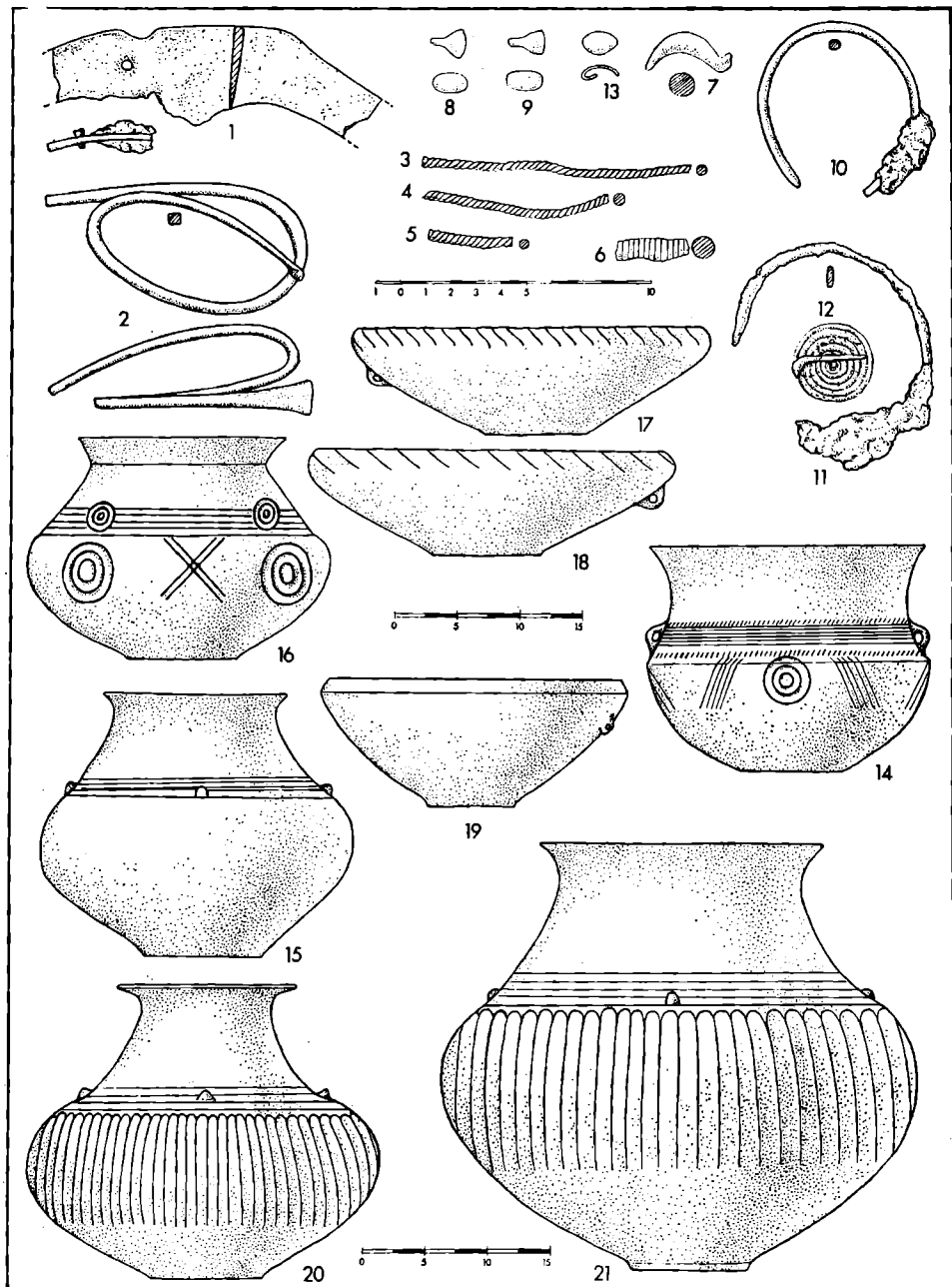

Taf. 58 — Brno-Obřany, Grab 140

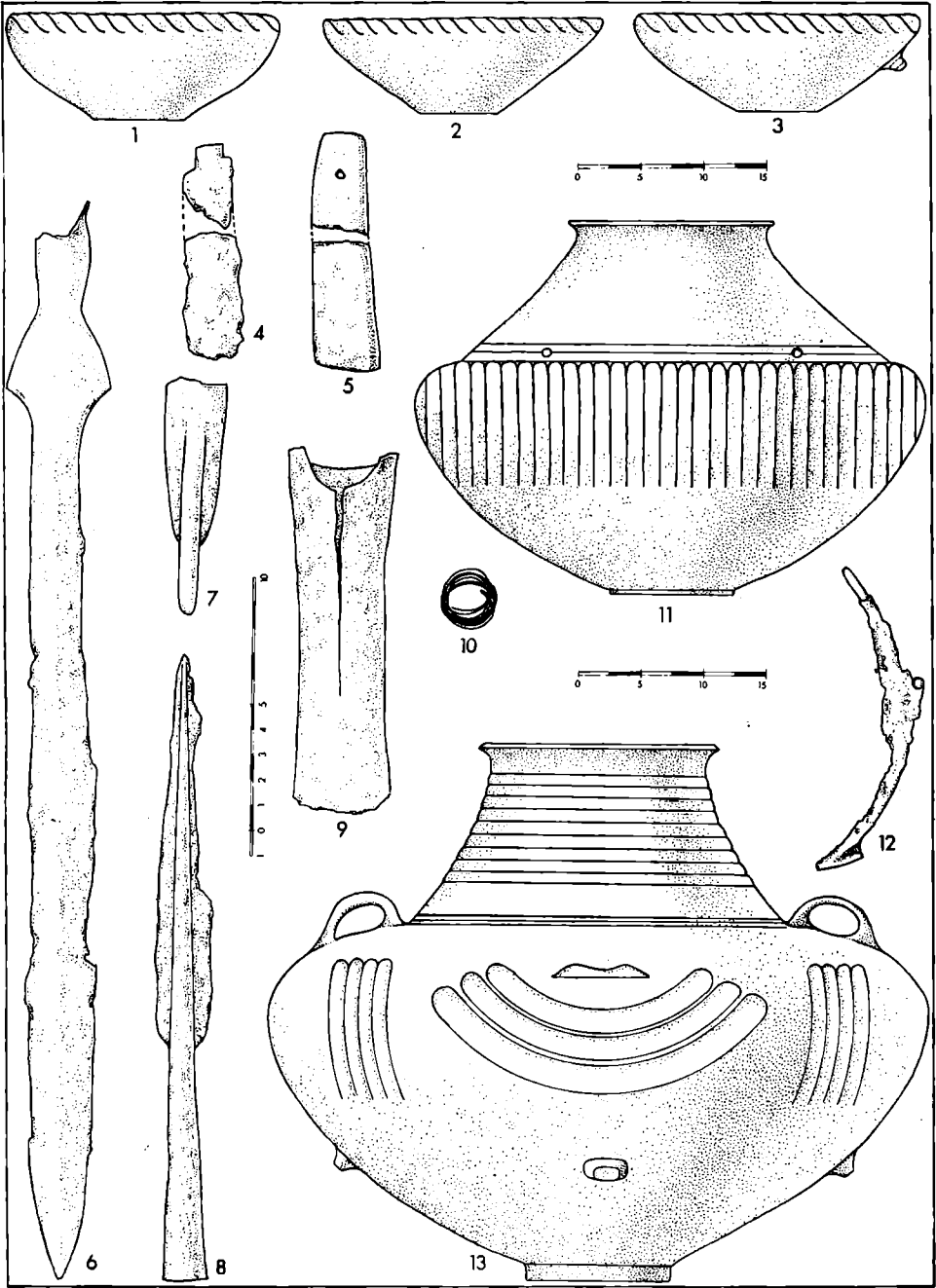

Taf. 59 — Brno-Obřany, Grab 169

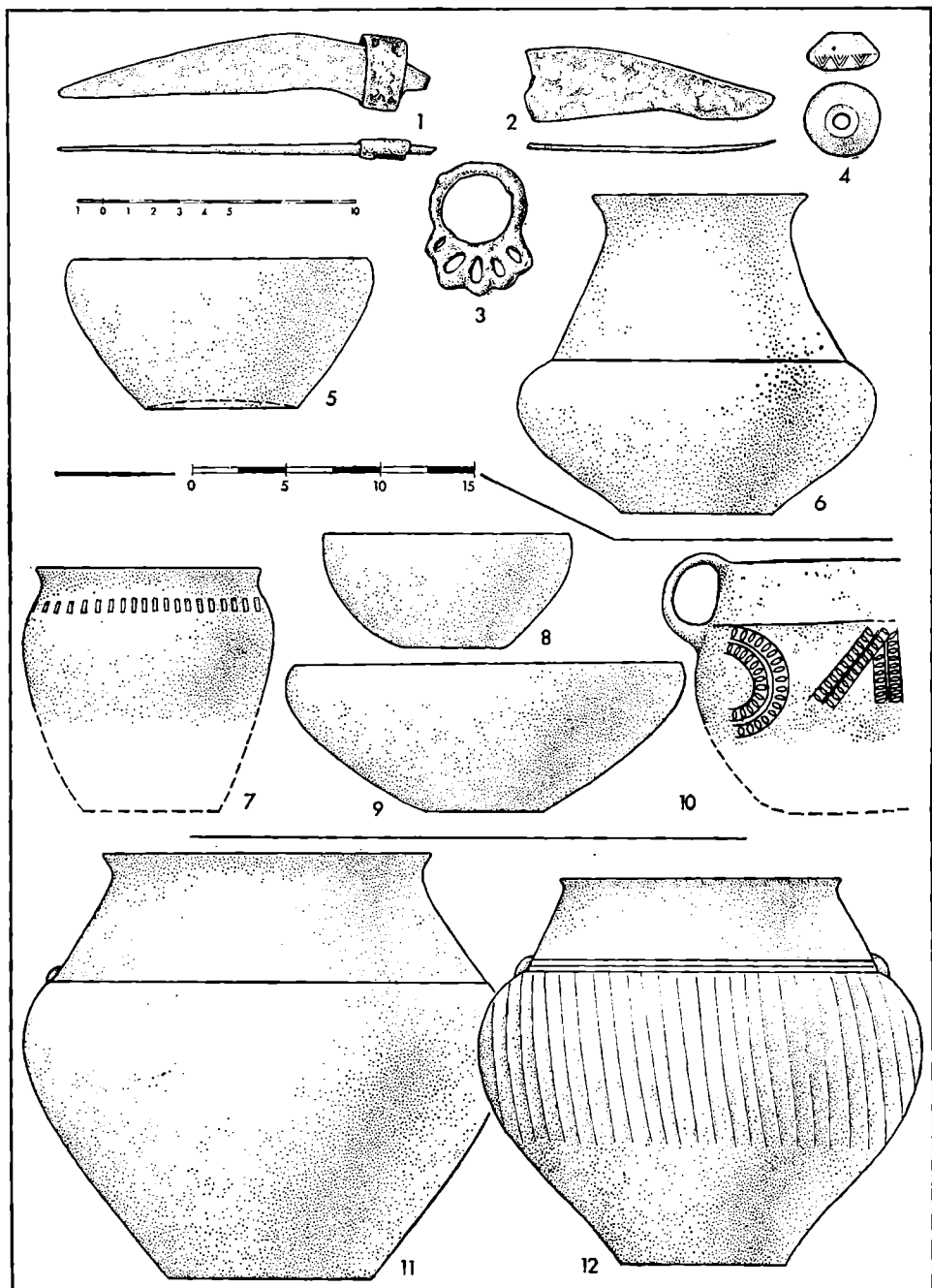

Taf. 60 — 1-6 — Mutěnice, Grab; 7-10 — Podolí, Grab 50; 11-12 — Podolí, Grab 51

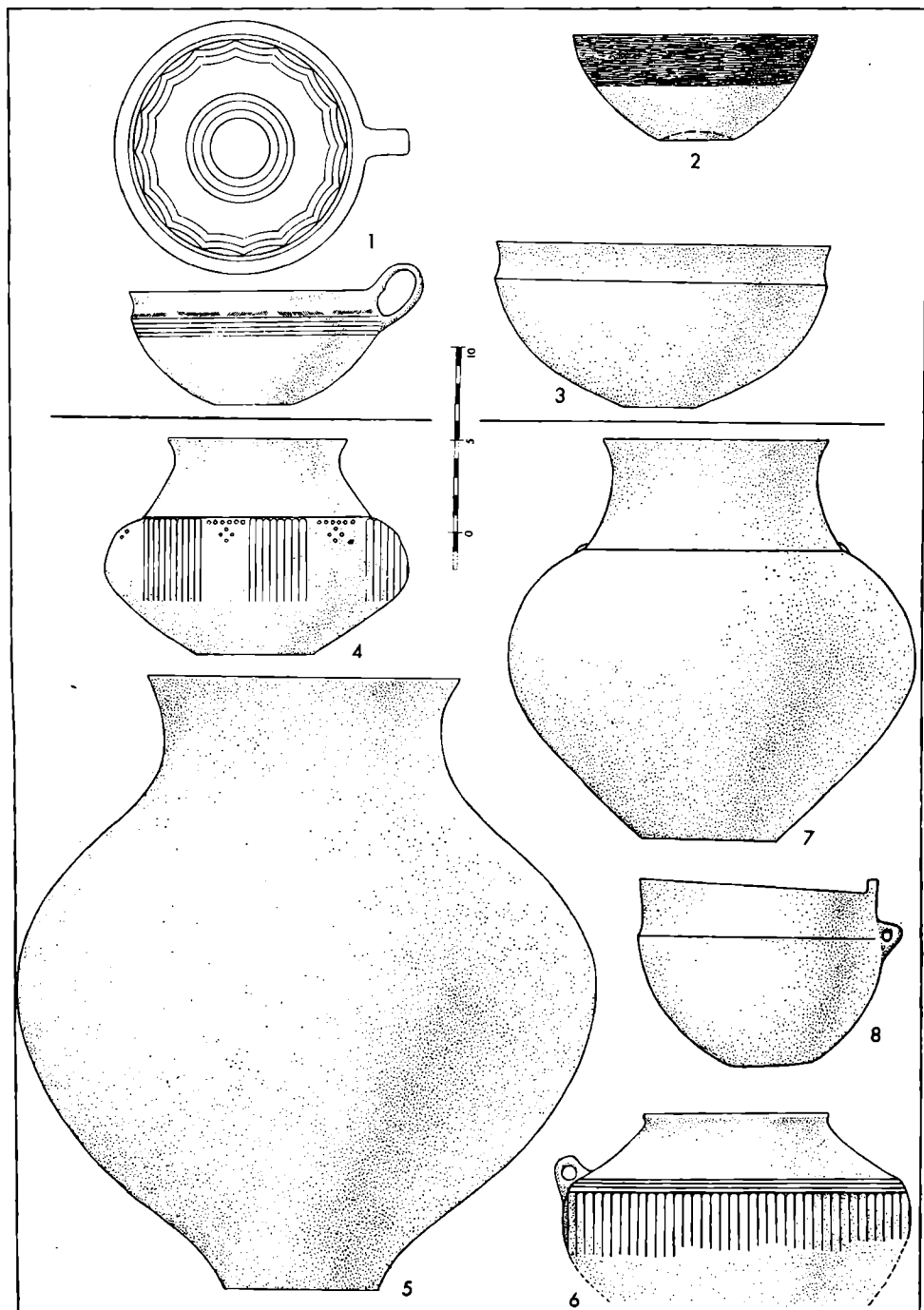

Taf. 61 — 1-3 — Horní Dubňany; 4-5 — Přímětice, Grab; 6 — Brno-Tuřany;  
7 — Lovčičky; 8 — Moravské Knínice



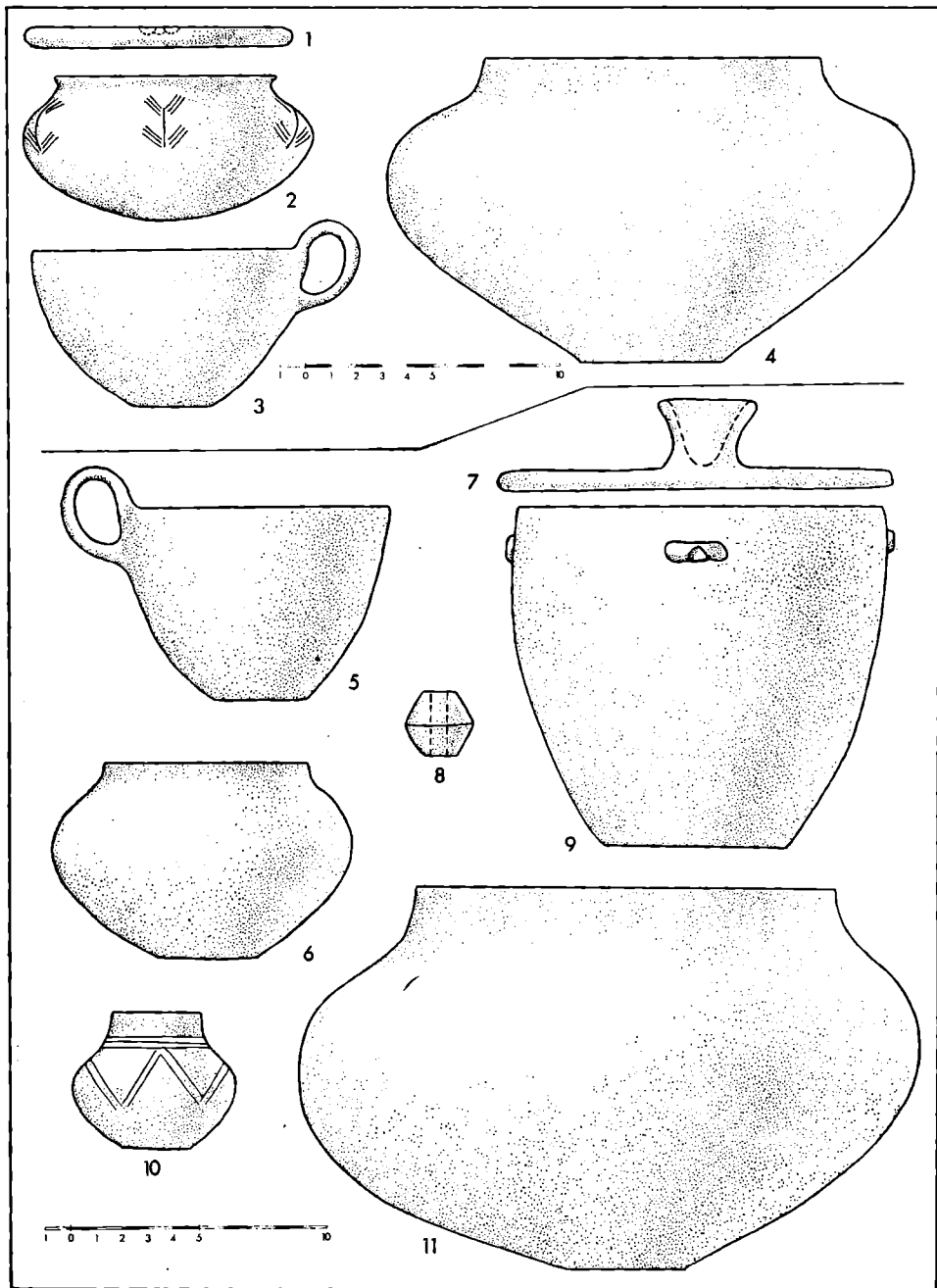

Taf. 62 — 1—4 — Slatinky, Grab 8; 5—11 — Slatinky, Grab 21

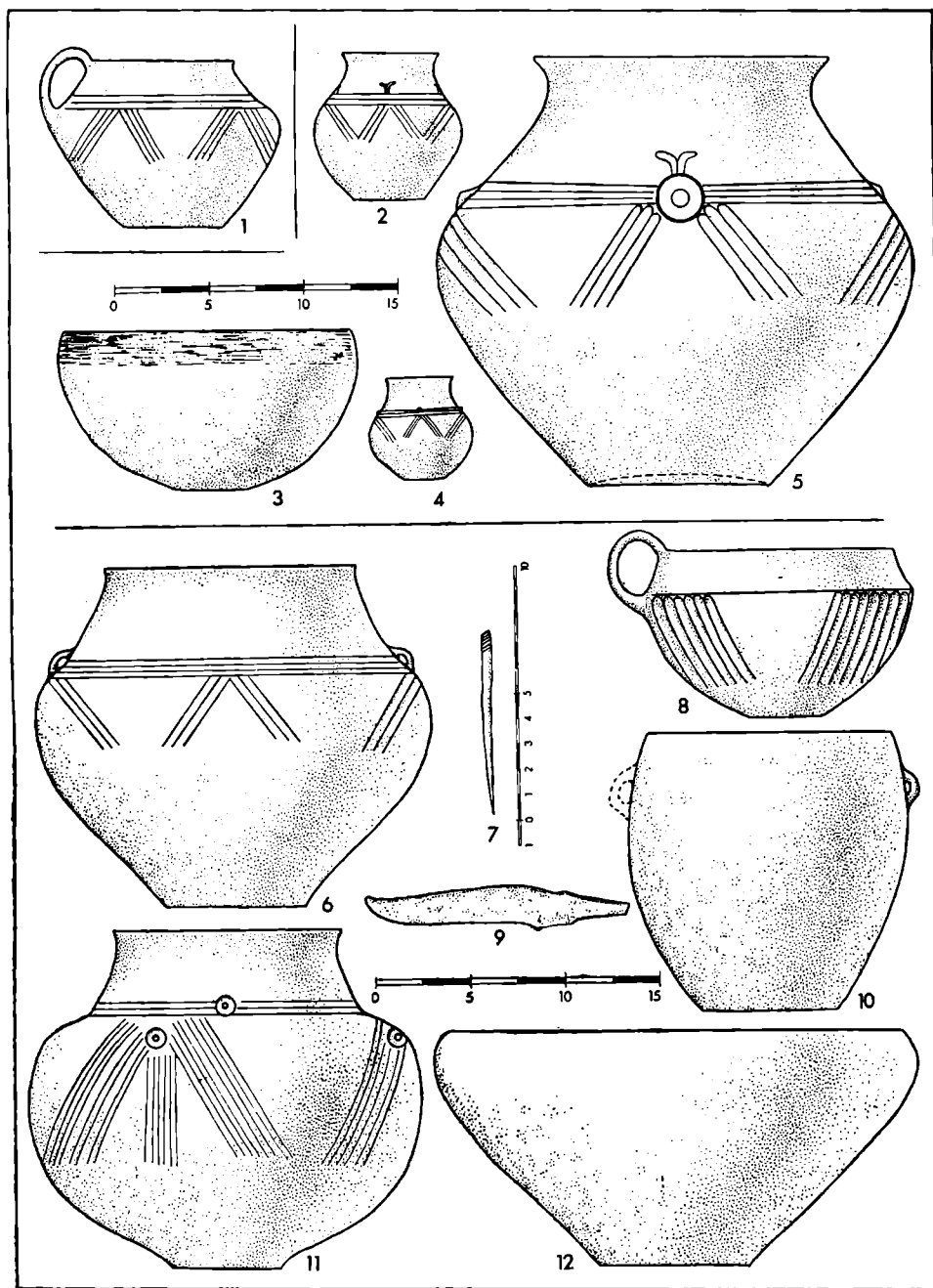

Taf. 63 — Určice-Kumberky, Grab 254 (Nr. 1), Grab 255 (Nr. 2-4)  
und Grab 247 (Nr. 5-13)

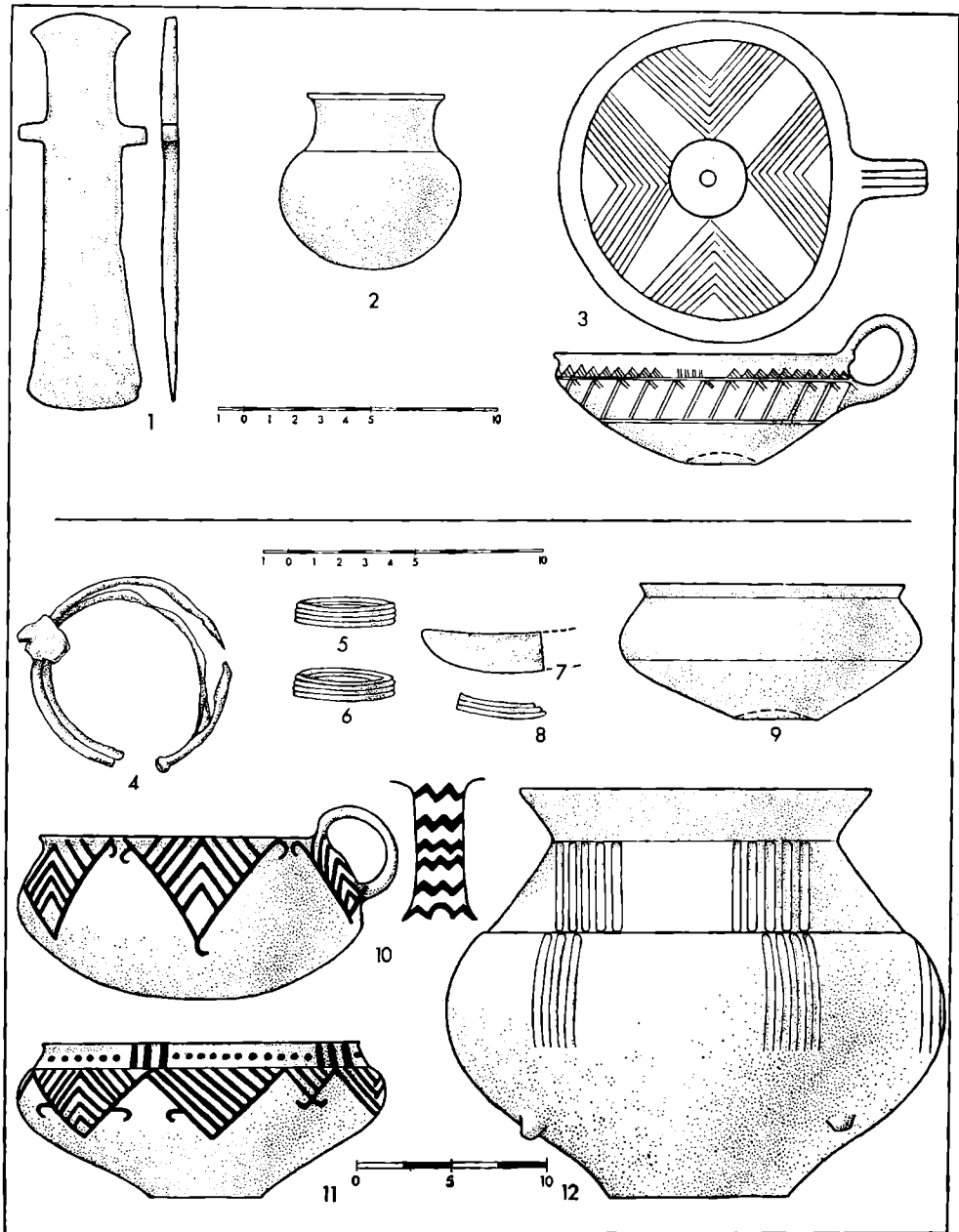

Taf. 64 — 1-3 — Určice-Hájové, Grab 1; 4-12 — Určice-Hájové, Grab 4

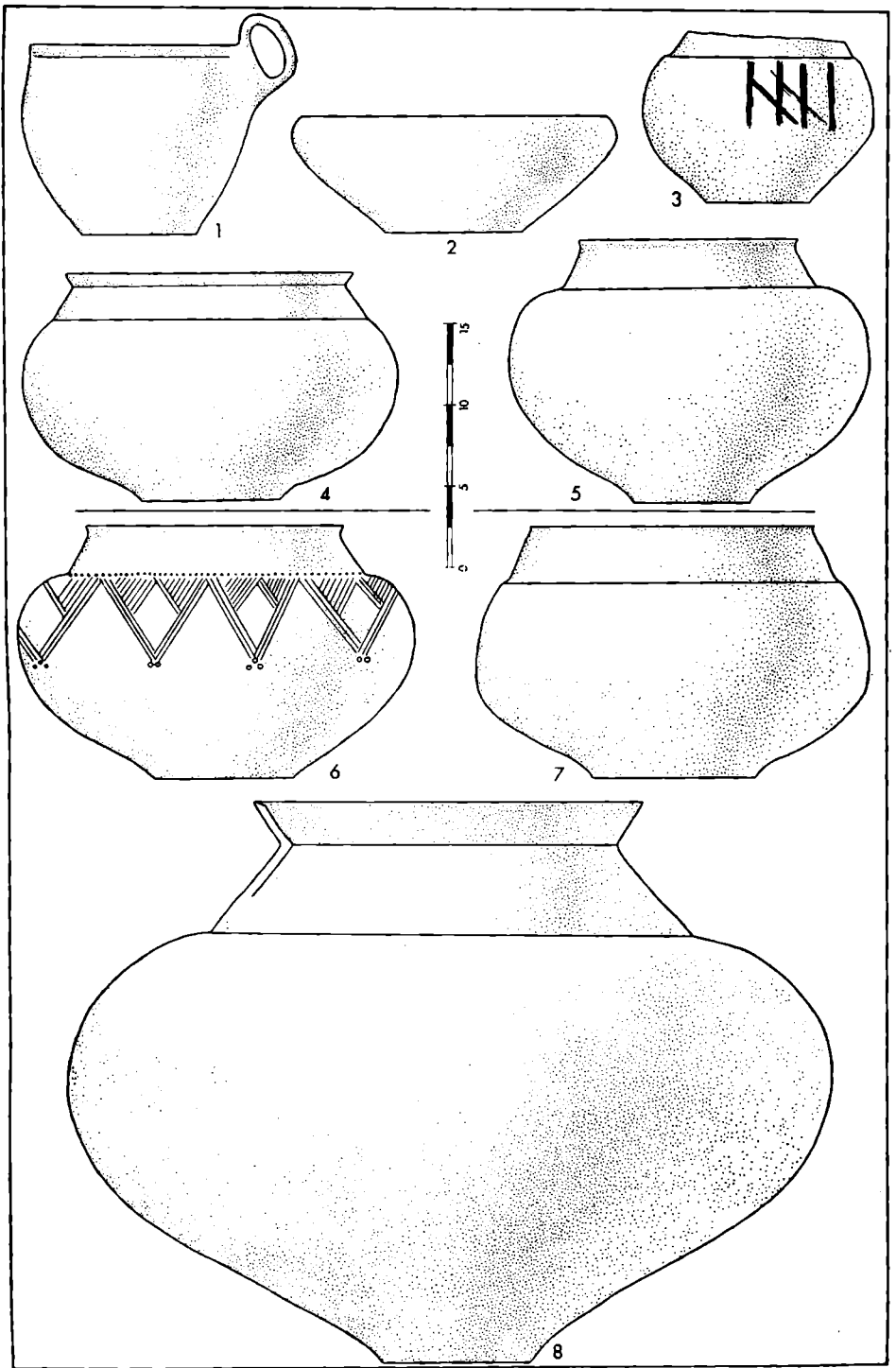

Taf. 65 - 1-5 - Ořechov, Grab 4; 6-8 - Klentnice, aus Gräbern

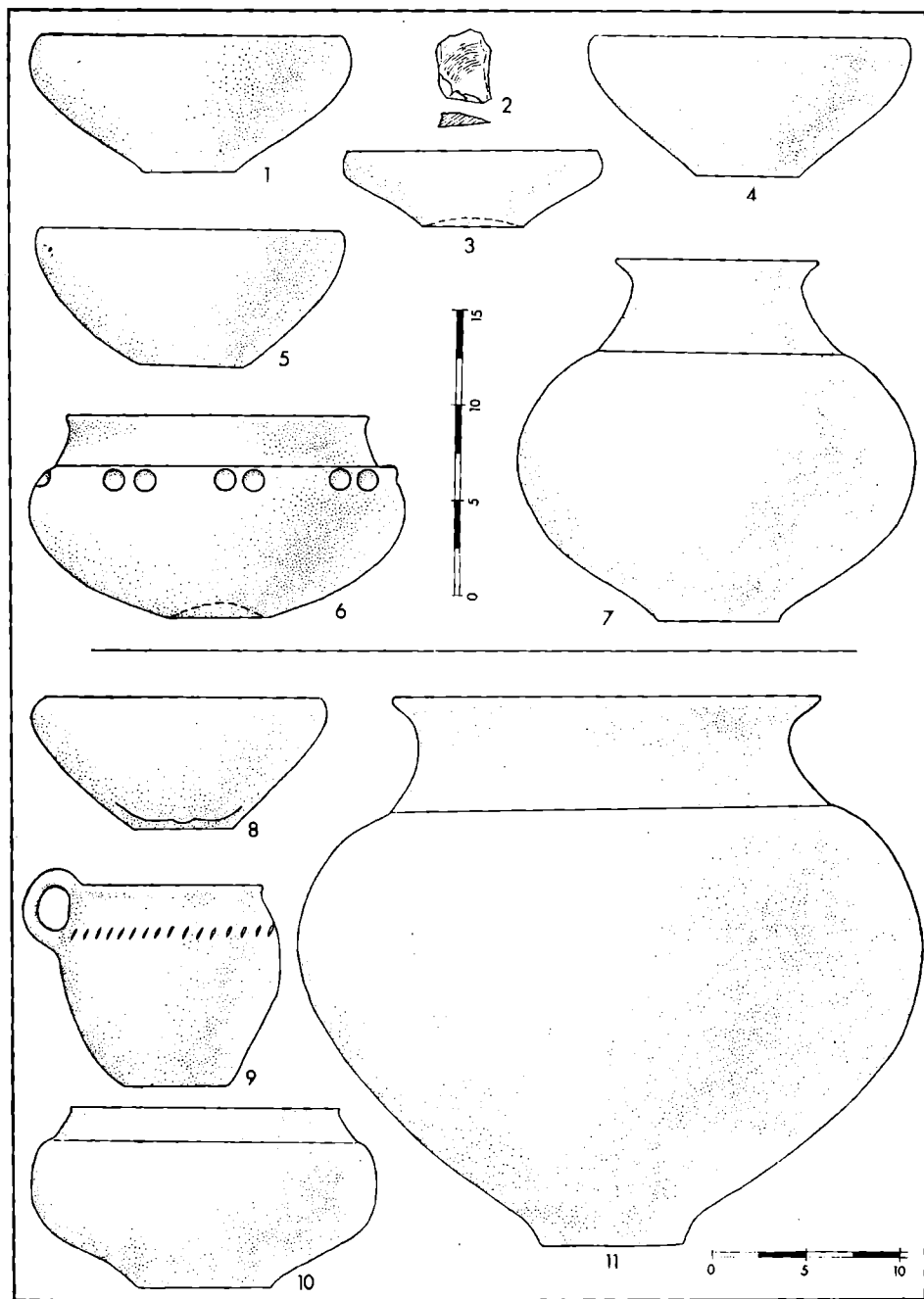

Taf. 66 — 1—7 — Těšetice, Grab 2; 8—11 — Neslovce-Zbýšov, aus Gräbern

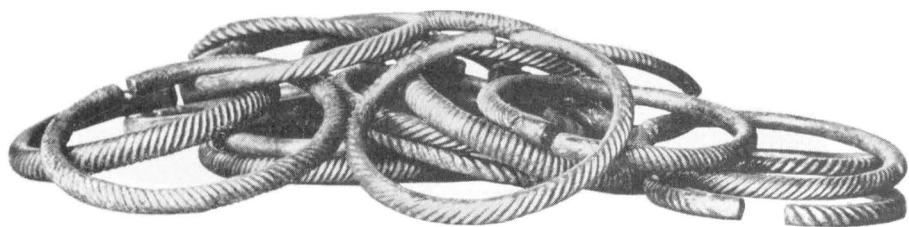

1

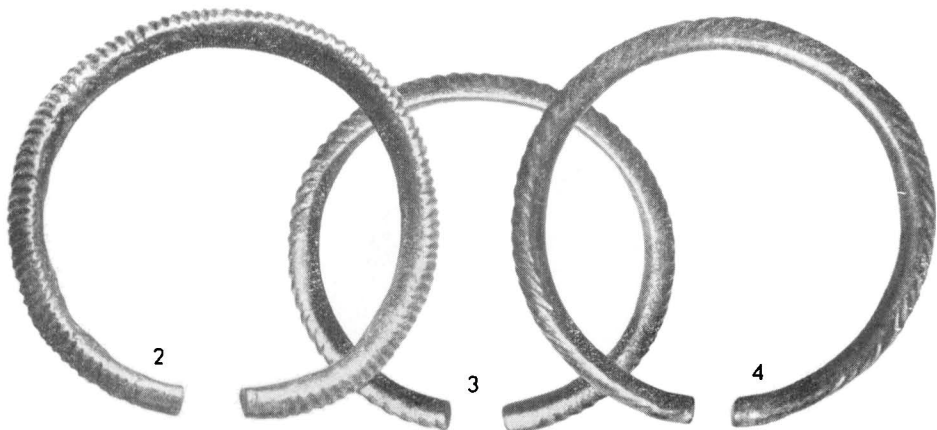

2

3

4

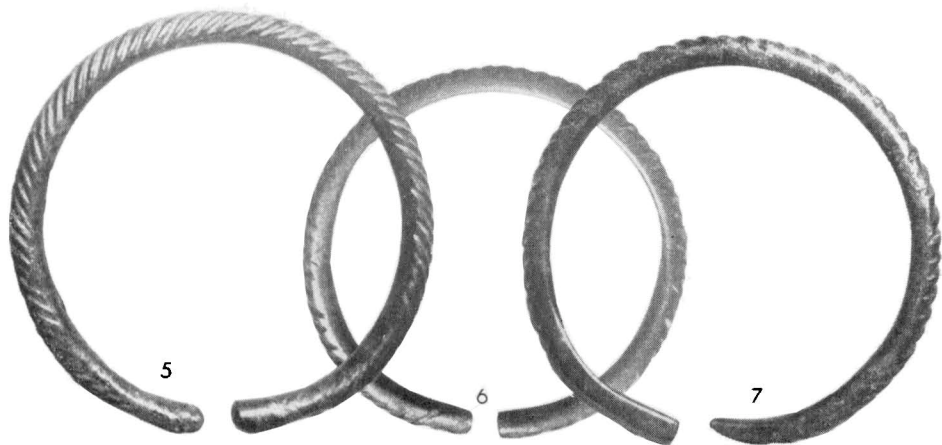

5

6

7

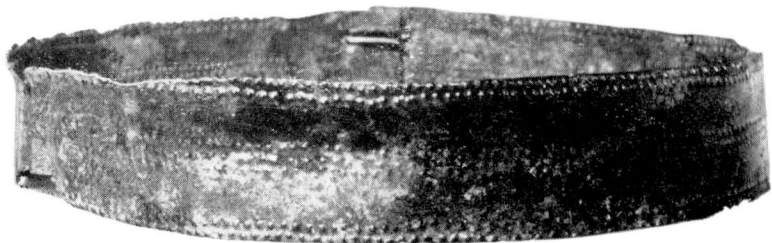
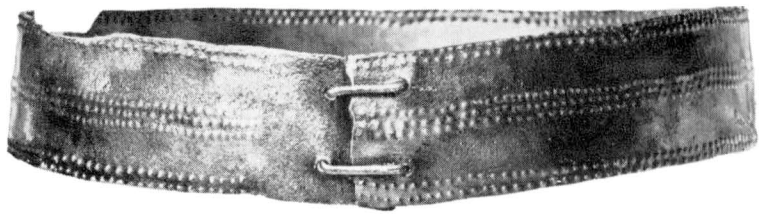

Taf. 68 — Štramberk-Kotouč, Diadem aus Depot 4

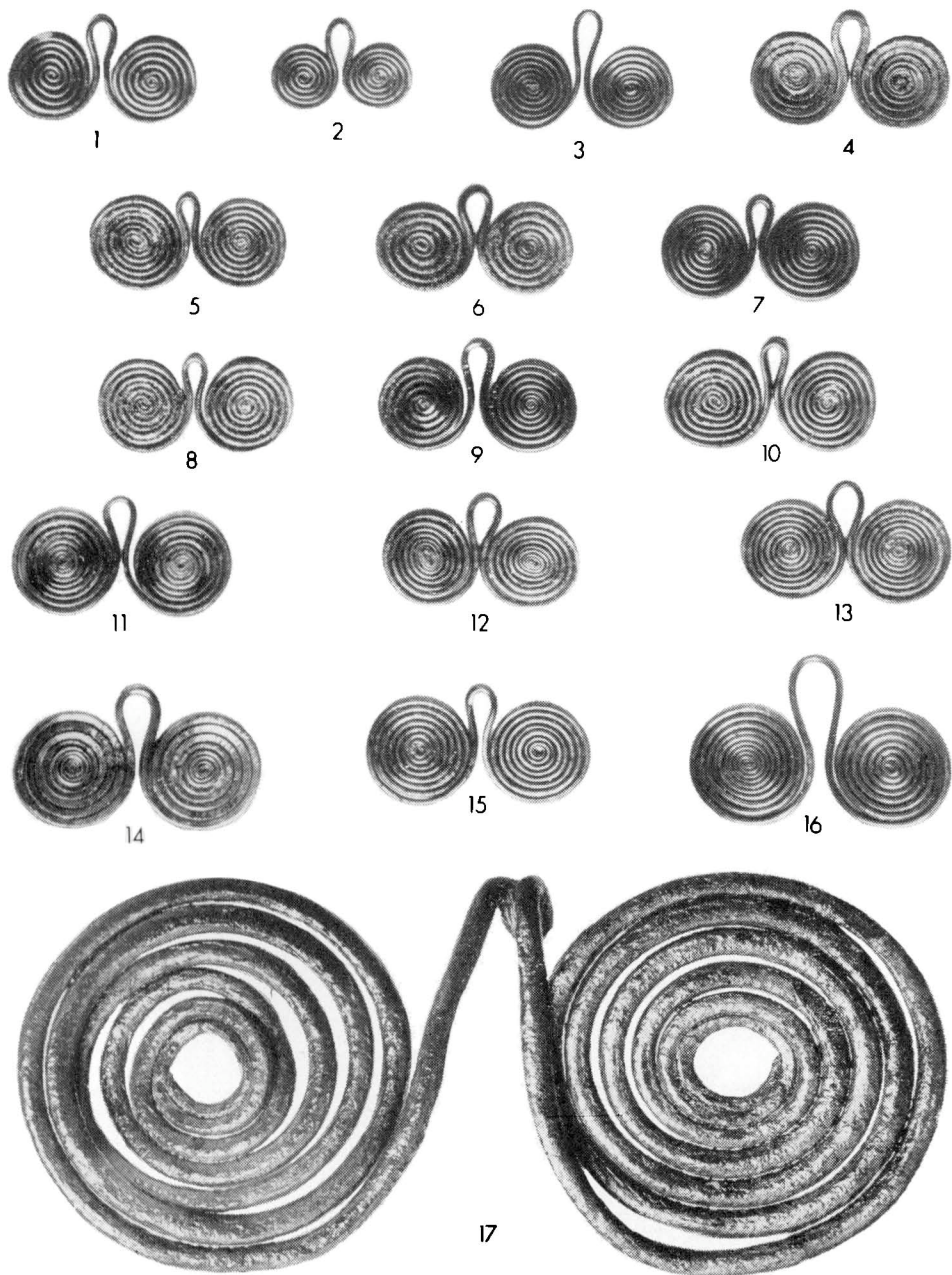

Taf. 69 — Štrambersk-Kotouč, 1–16 — Brillenverzierung aus Depot 2; 17 — Zufallsfund





1

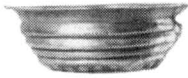

2



3



4

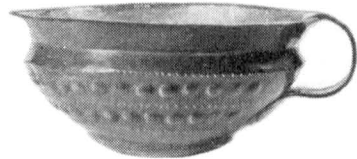

5

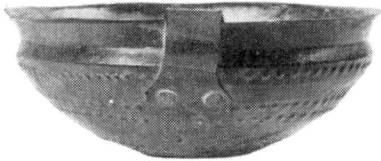

6



7



8

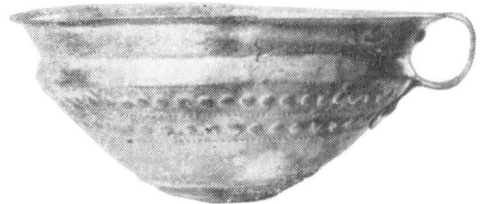

9a



10

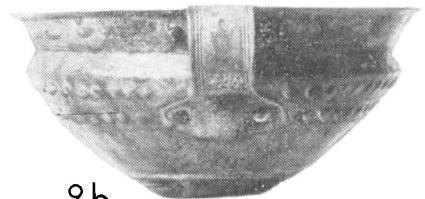

9b

Taf. 70 — 1—3 — Štramberk-Kotouč, kleine Gefäße vom Typus Štramberk aus Depot 4;  
4, 9, 10 — kleine Gefäße vom Typus Jenišovice-Kirkendrup aus Depot 2;  
5—8 — Křenůvky, kleine Gefäße vom Typus Jenišovice-Kirkendrup aus dem Depot

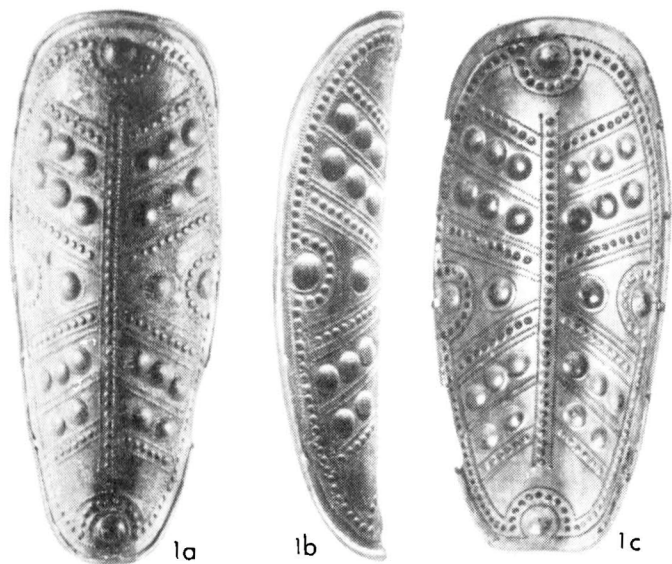

Taf. 71 — 1 — Kuřim; 2 — Úvalno

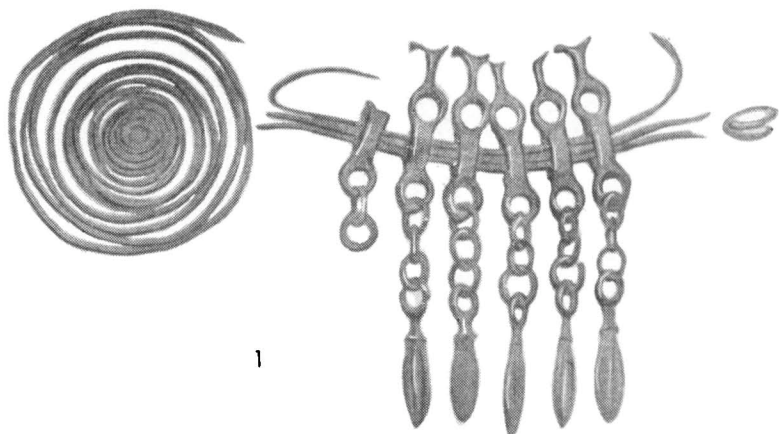

1

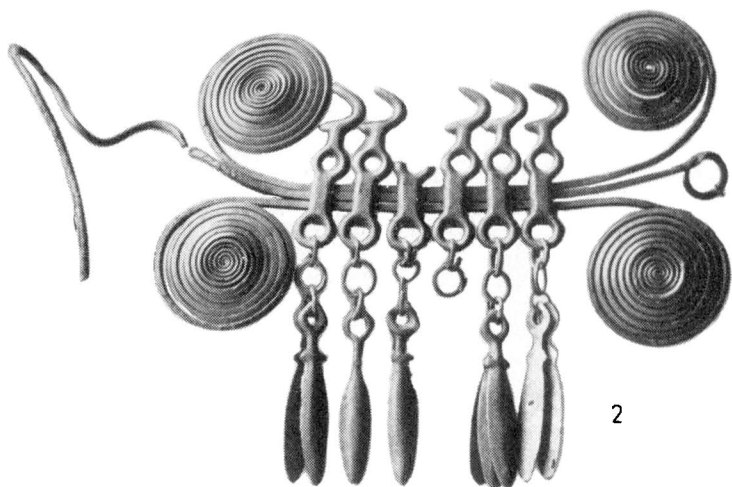

2

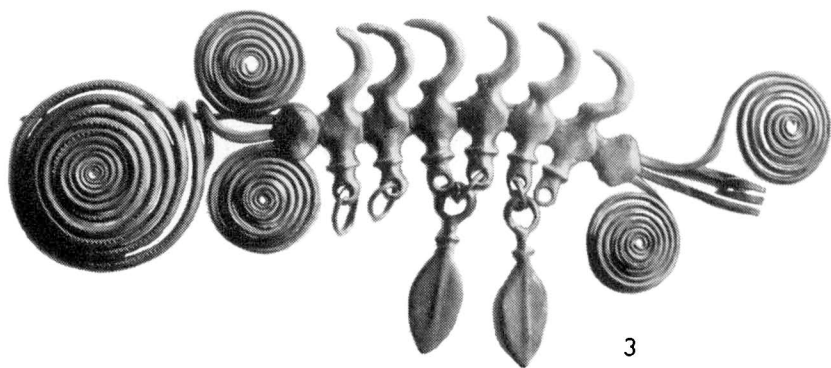

3

Taf. 72 — 1 — Salaš; 2 — Smržice; 3 — Dolany

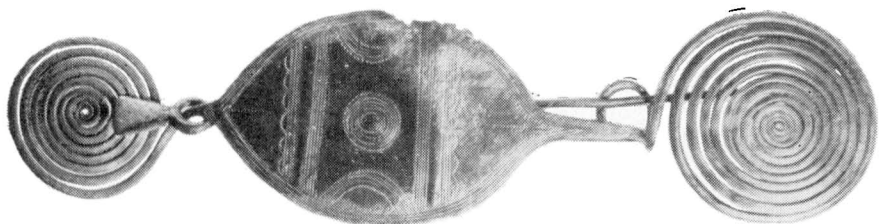

1

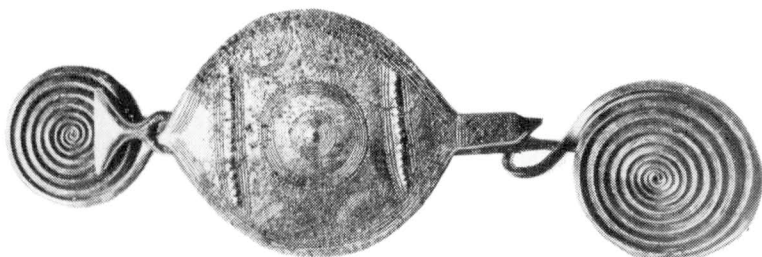

2

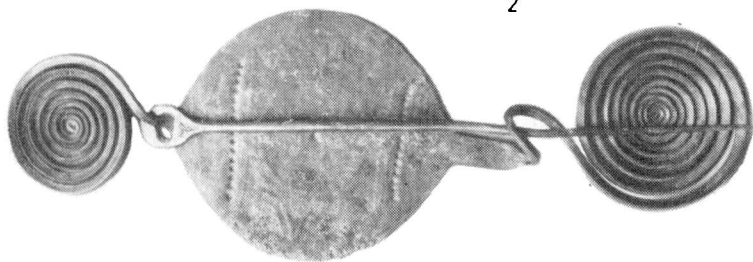

3

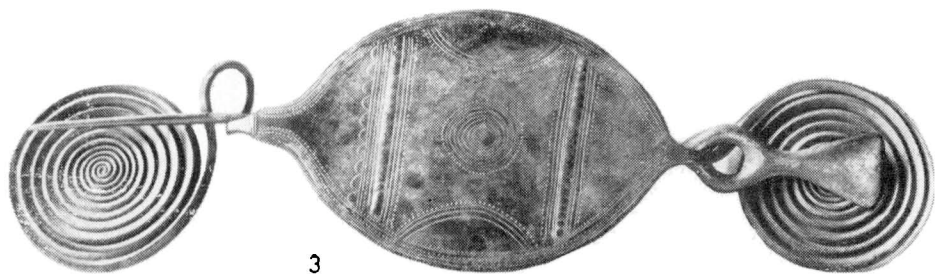

Taf. 73 — 1 — Štramberk-Kotouč, Depot 4; 2 — Štramberk-Kotouč, Depot 3;  
3 — Křenůvky, Depot



1



3



2

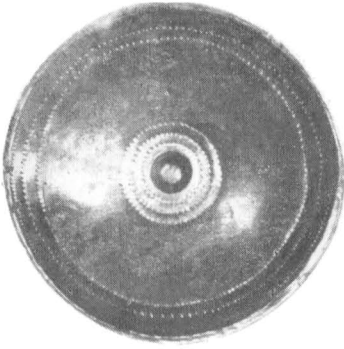

1

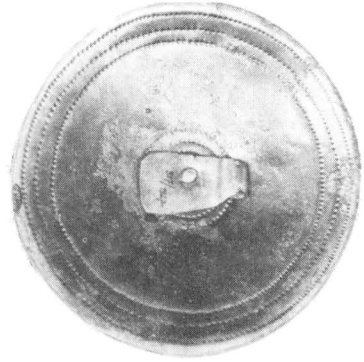

2

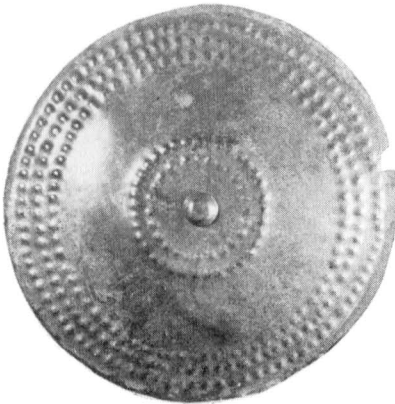

3



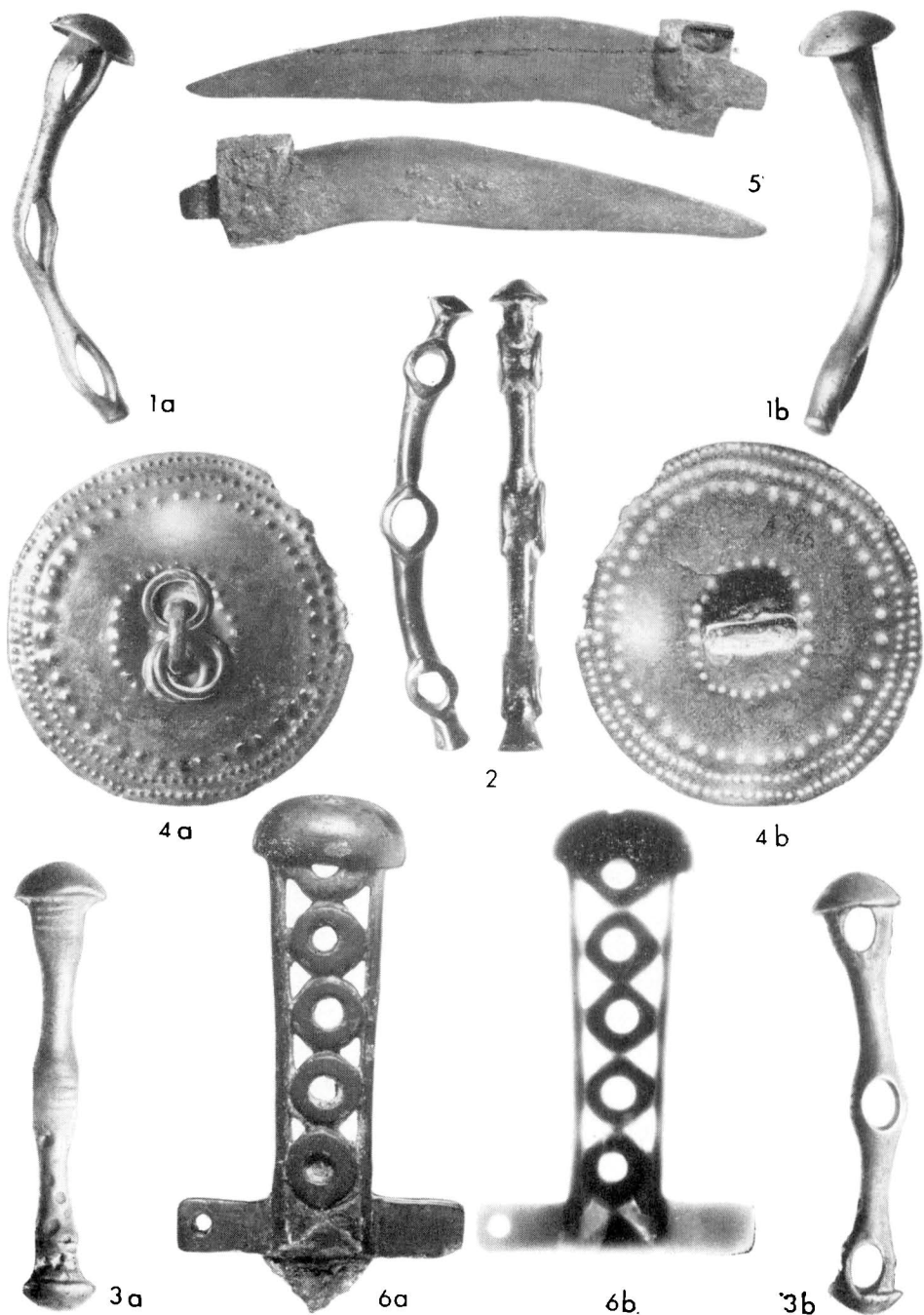

Taf. 76 — 1—4 — Černotín, Depot; 5 — Mutěnice, Grab; 6 — Štramberk-Kotouč, Depot 5

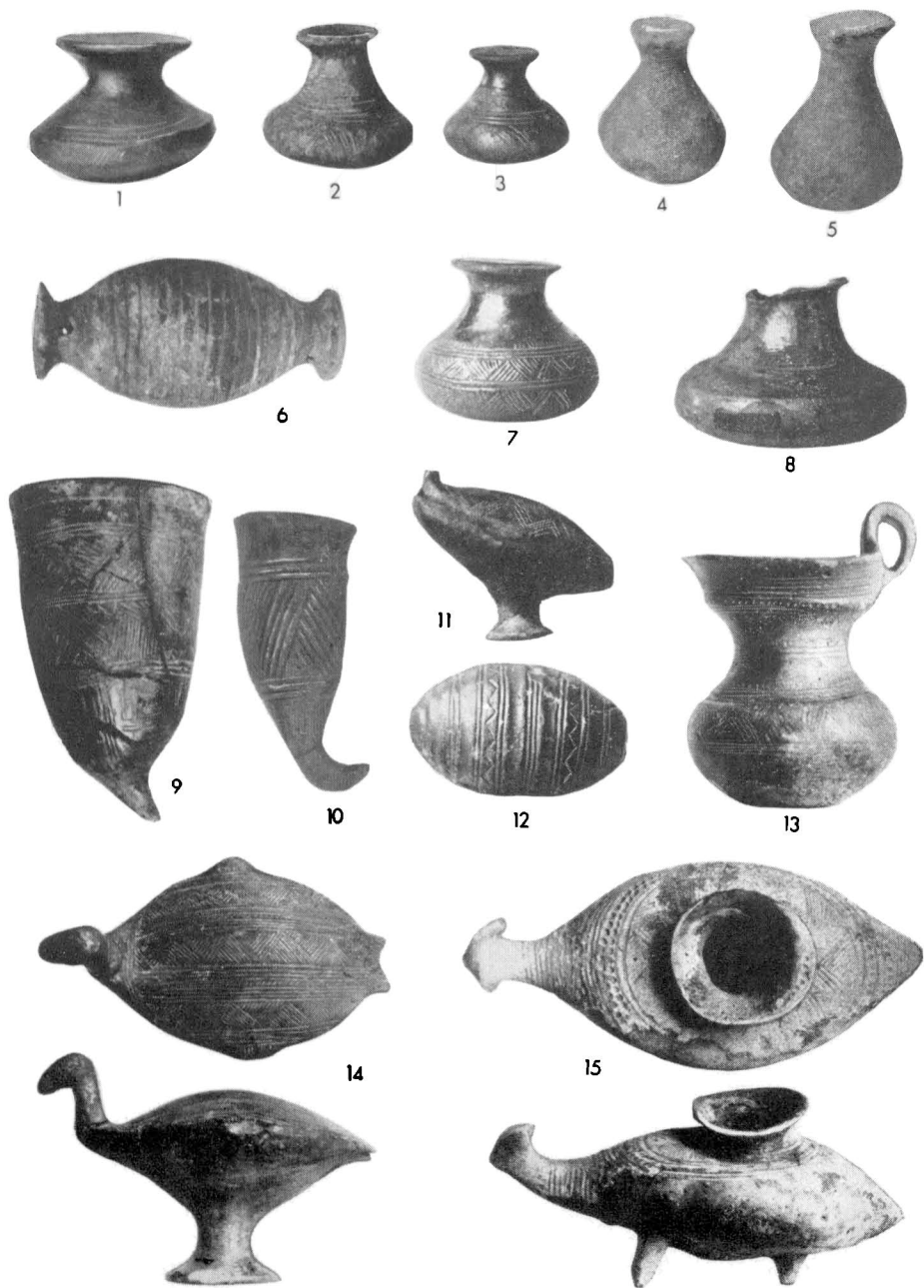

Taf. 77 — 1–11 — Domamyslice, aus Gräbern; 12 — Ptení; 13 — Horka n. M.;  
 14 — Uničov-Benkov; 15 — Želechovice



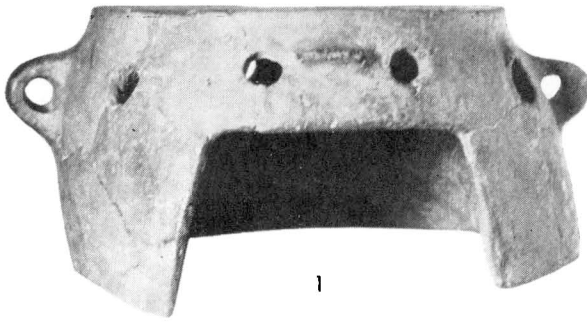

1



2



3

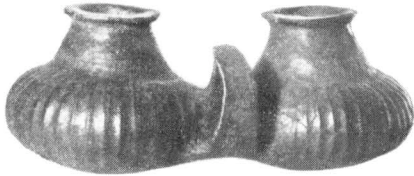

5

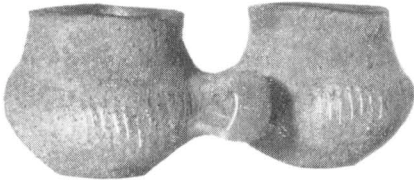

6



4

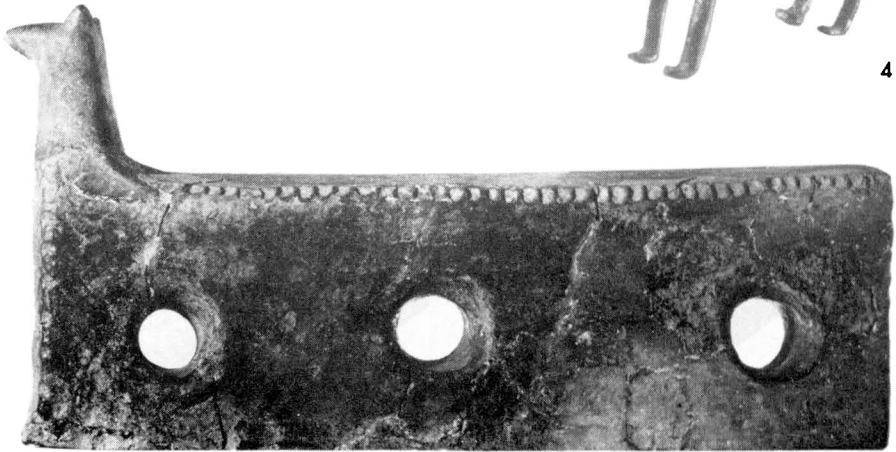

7

Taf. 78 — 1, 2, 4–7 — Brno-Obřany; 3 — Křevice

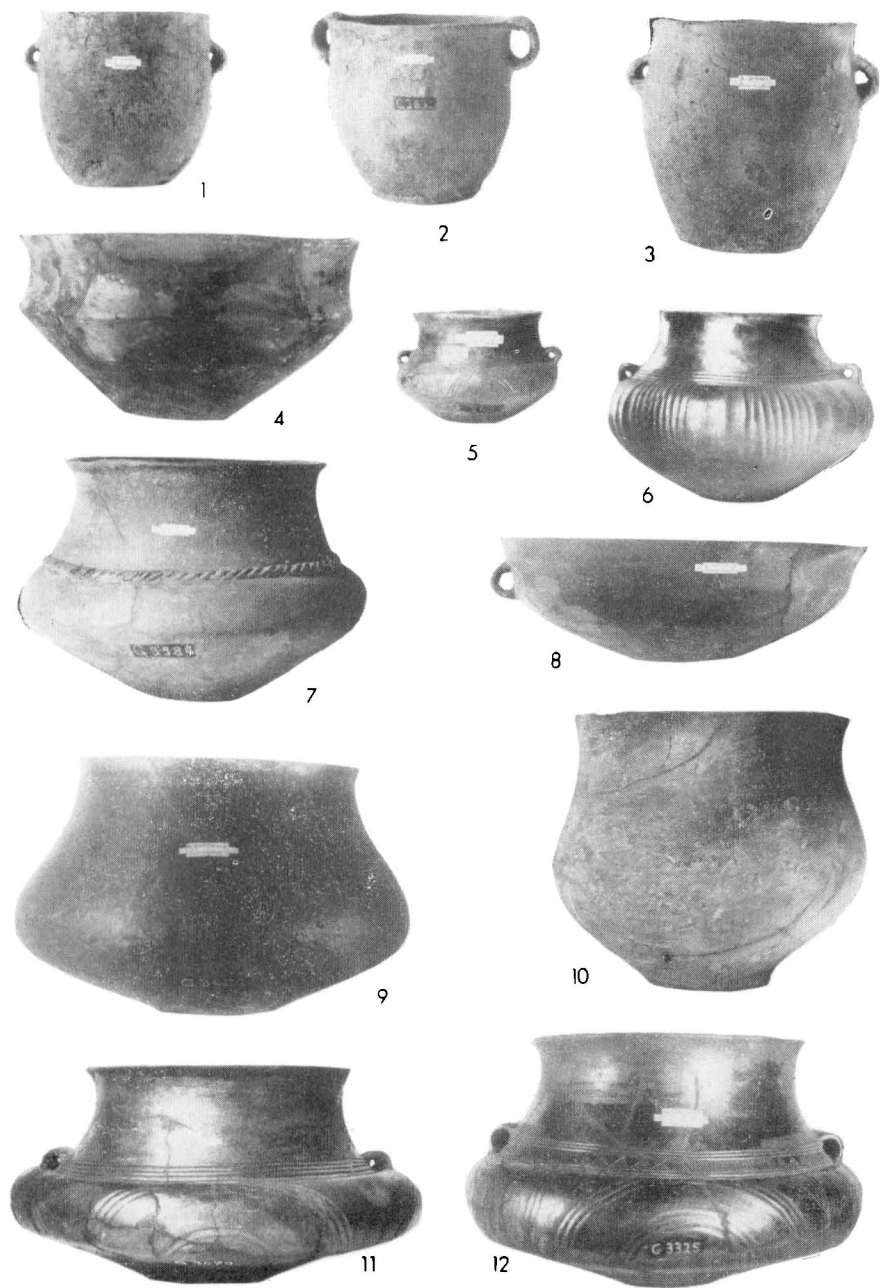

Taf. 79 — Domamyslice, Keramik aus Gräbern der schlesischen Kultur

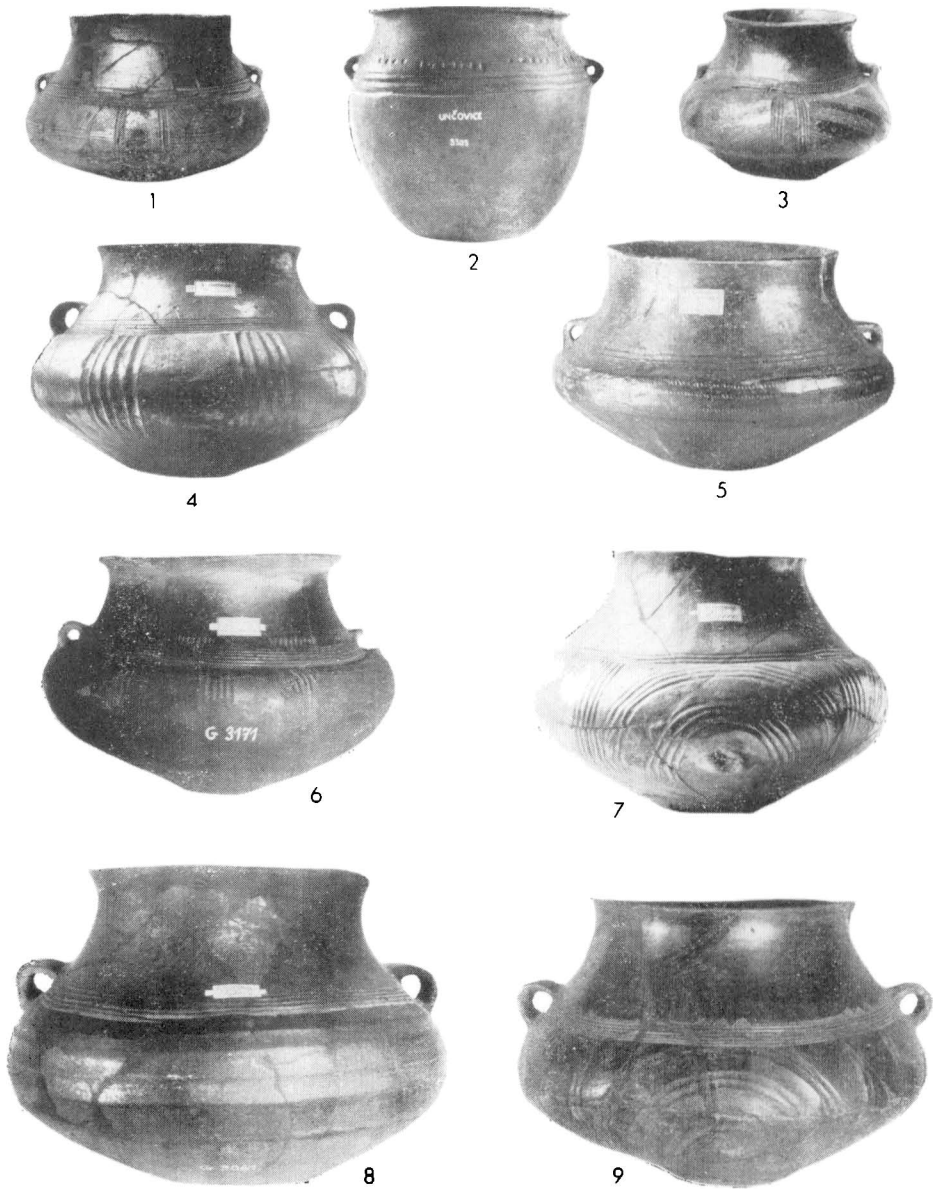

Taf. 80 — Schlesische Keramik aus verschiedenen Gräberfeldern: 1, 3 — Domamyslice; 2 — Unčovice; 4, 7 — Určice; 5 — Krumšín; 6 — Čelechovice; 8 — Slatinky; 9 — Uničov

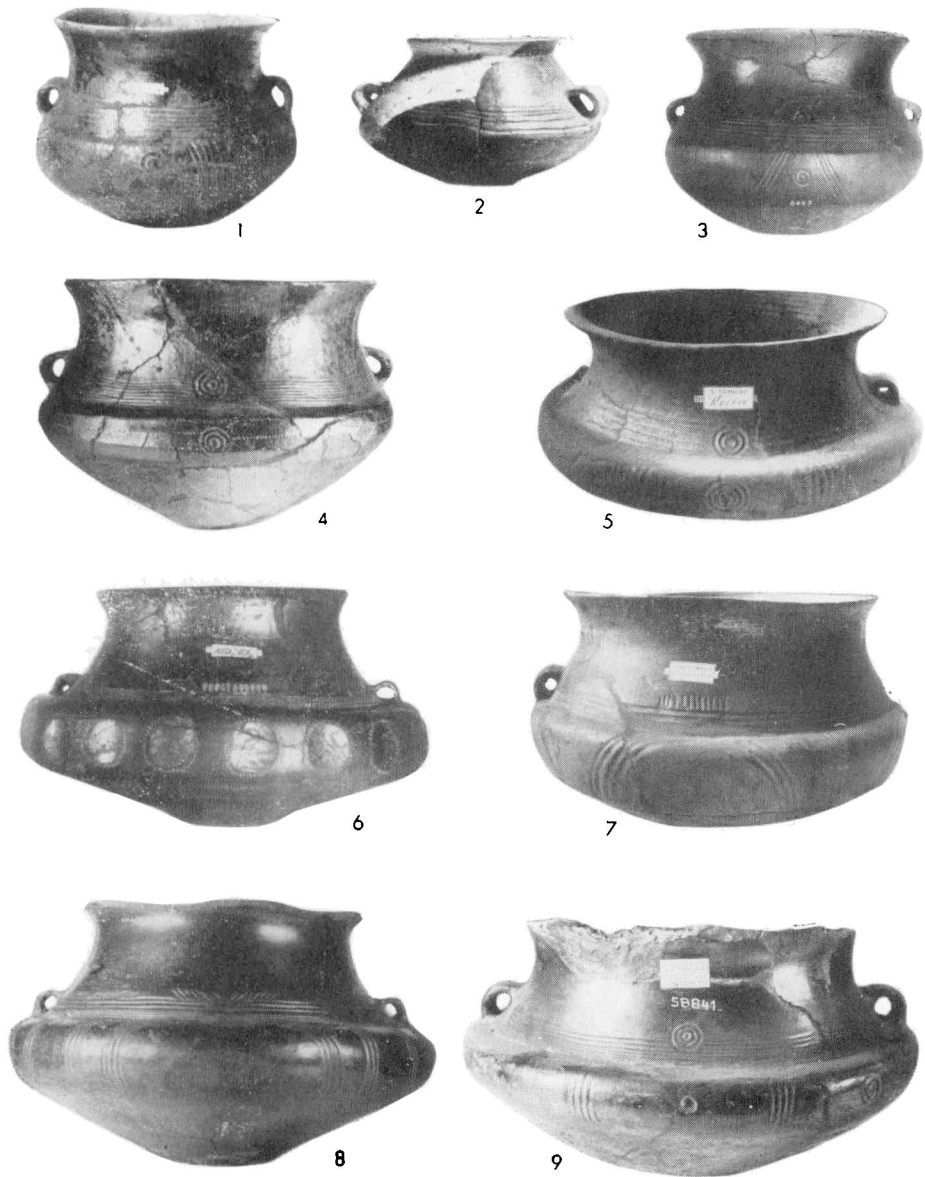

Taf. 81 — Jüngere schlesische Keramik aus verschiedenen Gräberfeldern: 1, 3 — Horka n. M.;  
 2 — Podhradí; 4 — Předmostí; 5 — Určice; 6 — Slatinky; 7 — Čelechovice;  
 8 — Brno-Obřany; 9 — Krumstín



Taf. 82 — Schlesische Keramik aus verschiedenen Gräberfeldern: 1, 2 — Horka n. M.;  
 3, 6 — Domamyslice; 4 — Brno-Židenice; 5 — Postoupky; 7 — Mohelnice;  
 8, 10 — Moravská Hůzová; 9 — Uničov-Benkov

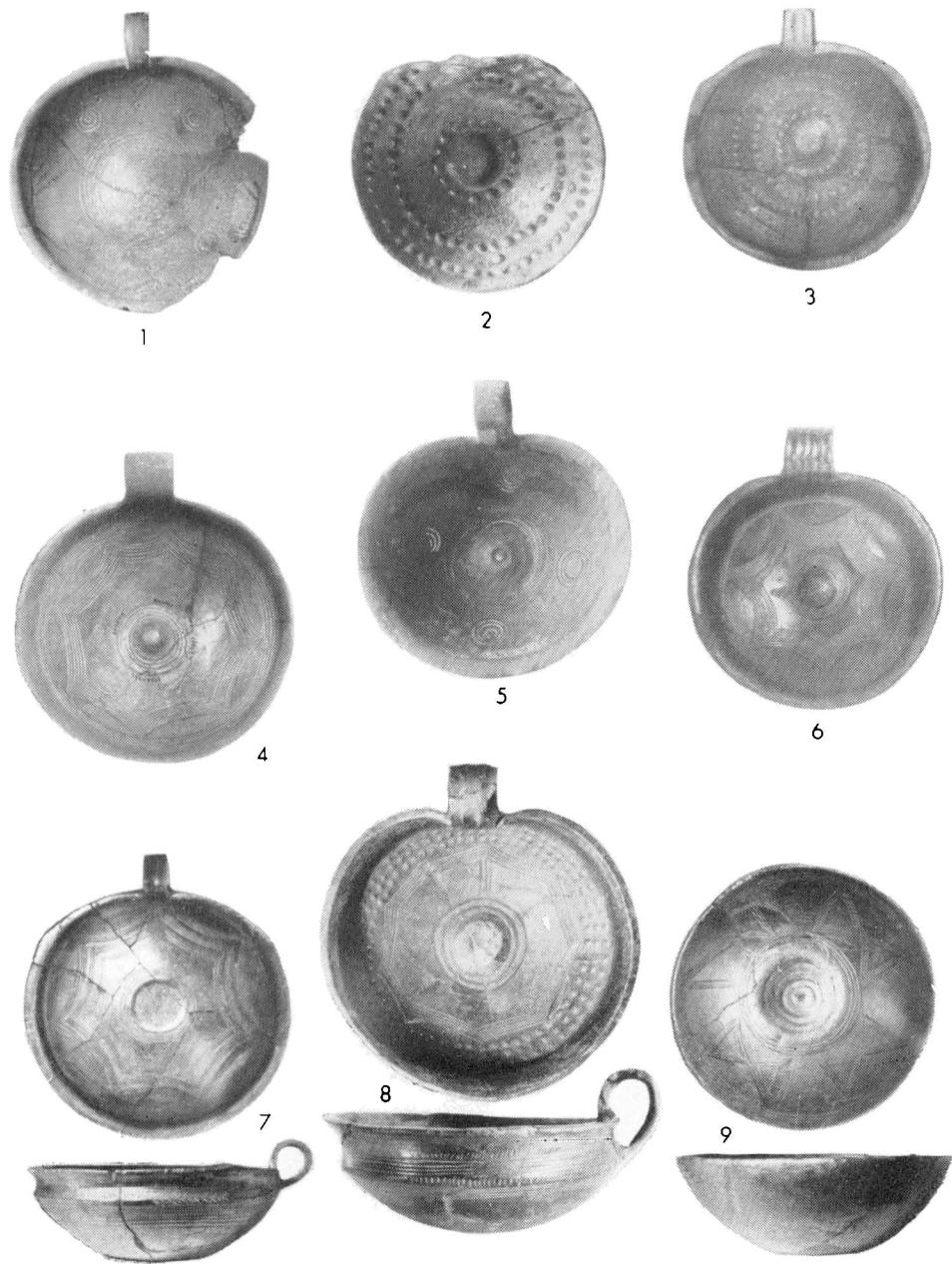

Taf. 83 -- Innenverzierung schlesischer Schalen: 1, 7 -- Horka n. M.; -- 2, 9 -- Krumsín;  
 3, 4, 6 -- Domamyslice; 5 -- Ptení; 8 -- Postoupky



1



2



3



5



4



6

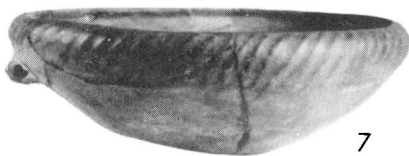

7

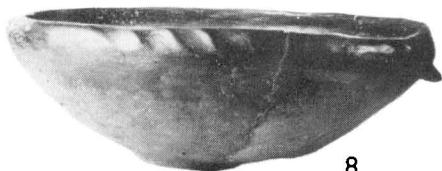

8



9

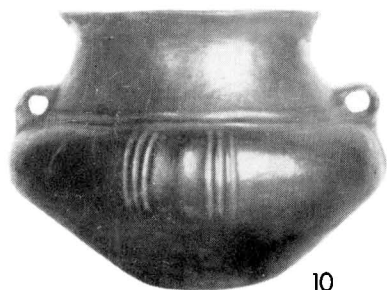

10

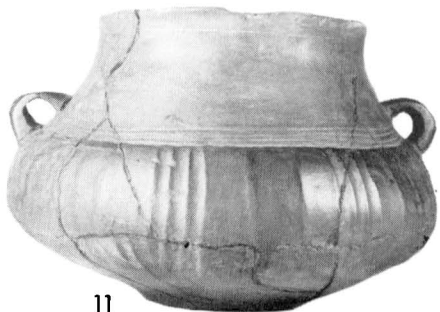

11

Taf. 84 — Brno-Obrány, Podoler und schlesische Keramik aus der dortigen Siedlung und den Gräbern



1



2

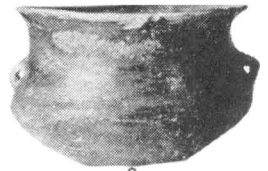

3



4



5



6

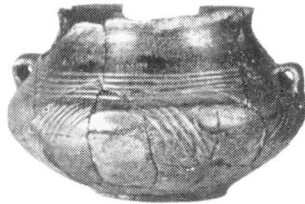

8



7



9

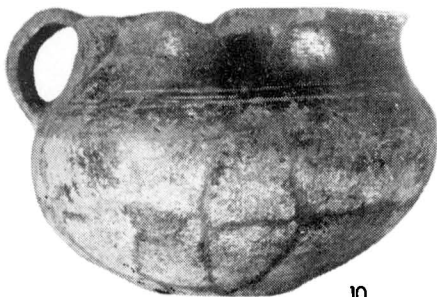

10



11

Taf. 85 — Podoli, Podoler Keramik vom Gräberfeld





Taf. 86 — Podoler Keramik aus verschiedenen Lokalitäten Südmährens: 1, 8 — Křepice; 2 — Vicemilice; 3, 7 — Velatice; 4 — Brodek; 5 — Moravský Krumlov; 6 — Znojmo-Hradiště



1



2



3



4

Taf. 87 — Amphorenartige Vorratsgefäße der Podoler Kultur:  
1, 3 — Brno-Obřany; 2 — Křepice; 4 — Kobylnice



1



2



3



4

Taf. 88 — Amphorenartige Vorratsgefäße der Althorákovér Kultur:  
1 — Neslovice-Zbýšov; 2, 4 — Velké Hostěrádky — Skřípov; 3 — Oslavany

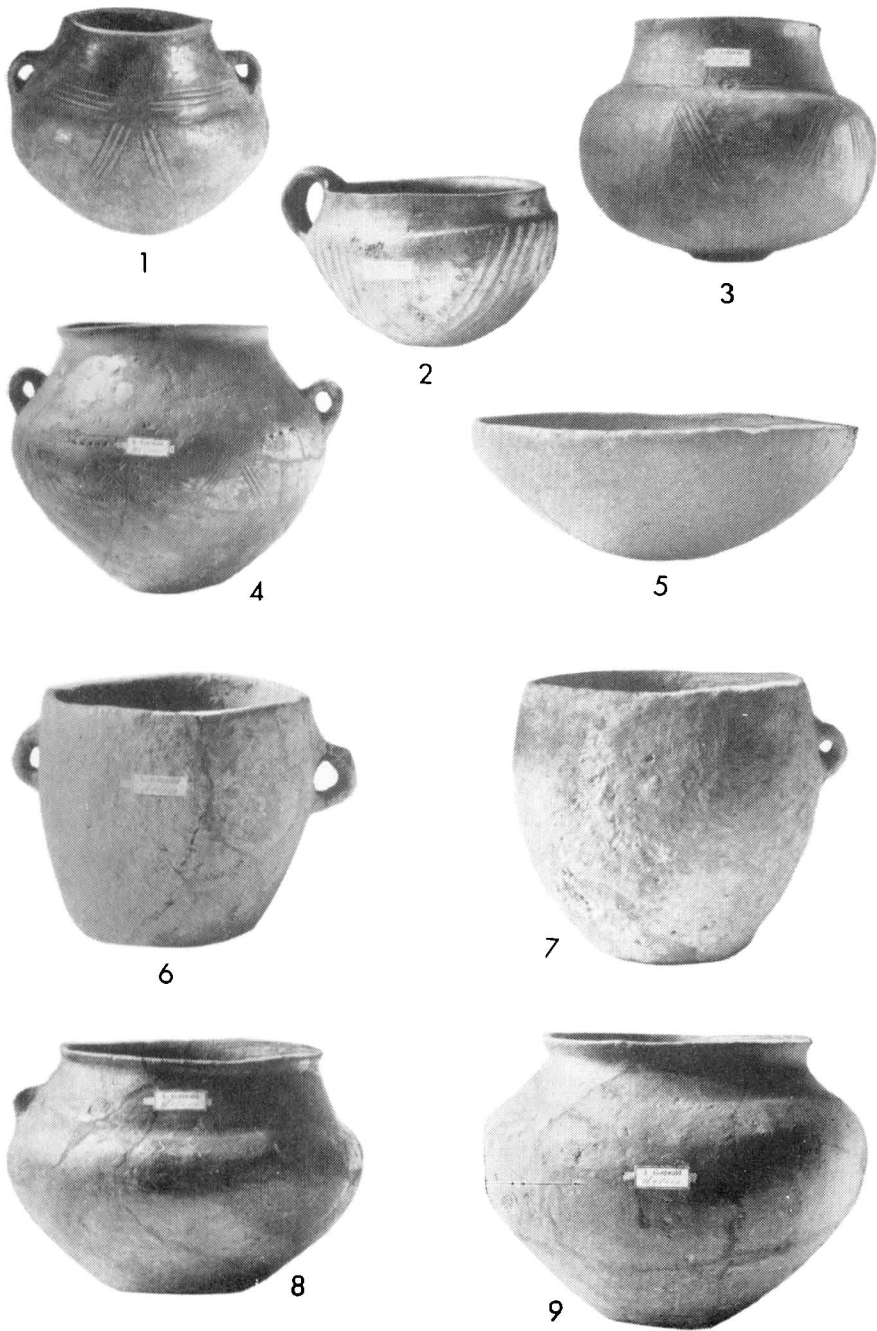

Taf. 89 — Altplatěnicer Keramik: 1 — Babice; 2—9 — Určice-Kumberky, aus Gräbern

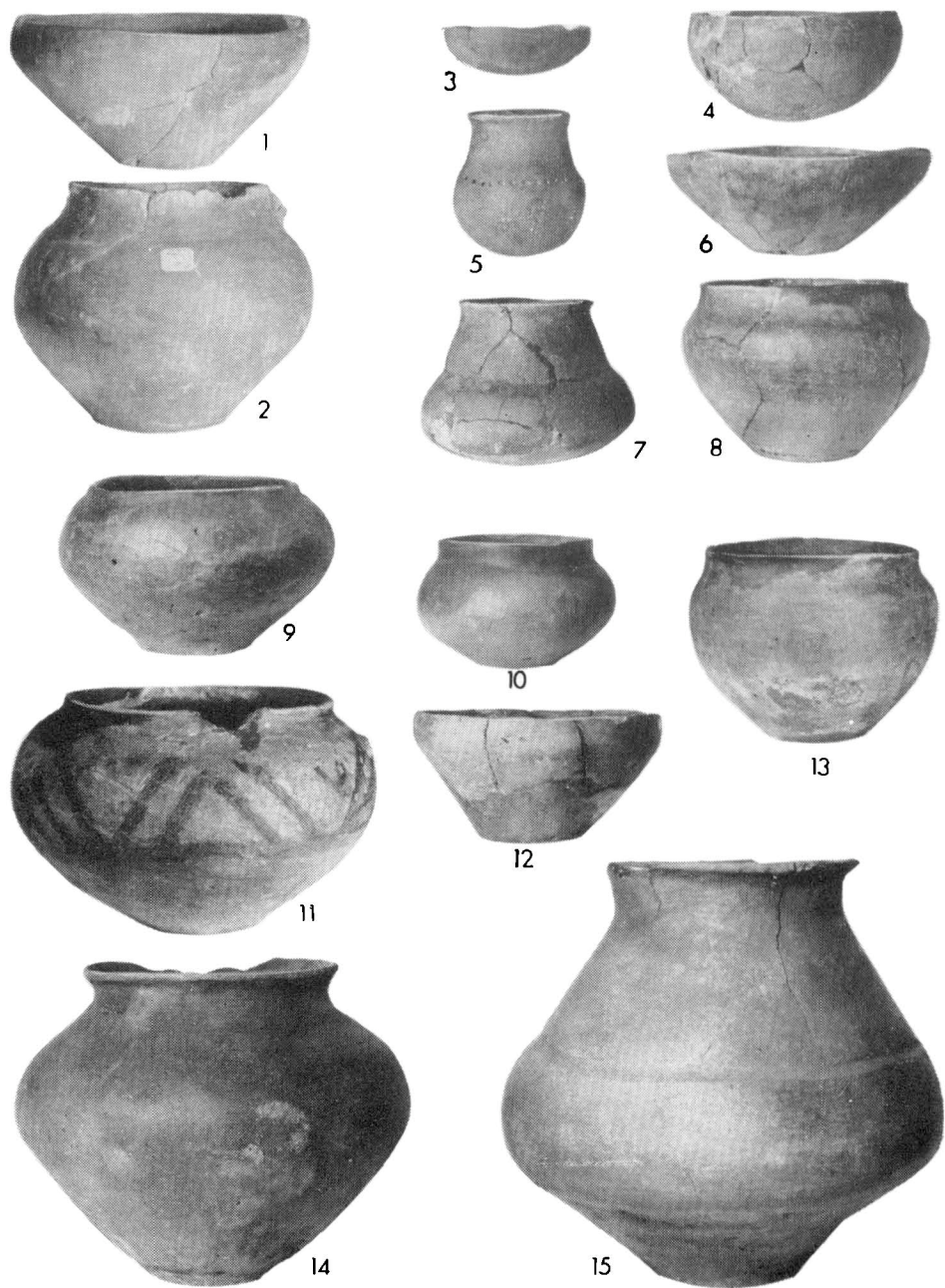

Taf. 90 — Althorákovér Keramik: 1, 2 — Brankovice; 3–8 — Dukovany, aus Gräbern;  
 9–14 — Břeclav, aus Gräbern aus Alt-Břeclav; 15 — Břeclav, Hügelgrab (?)